

2-1-2016

ANALYTICAL MODELING OF RUTTING POTENTIAL OF ASPHALT MIXES USING HAMBURG WHEEL TRACKING DEVICE

Matias Mario Mendez Larrain

Follow this and additional works at: https://digitalrepository.unm.edu/ce_etds

Recommended Citation

Mendez Larrain, Matias Mario. "ANALYTICAL MODELING OF RUTTING POTENTIAL OF ASPHALT MIXES USING HAMBURG WHEEL TRACKING DEVICE." (2016). https://digitalrepository.unm.edu/ce_etds/116

This Thesis is brought to you for free and open access by the Engineering ETDs at UNM Digital Repository. It has been accepted for inclusion in Civil Engineering ETDs by an authorized administrator of UNM Digital Repository. For more information, please contact disc@unm.edu.

Matias Mario Mendez Larrain

Candidate

Civil Engineering

Department

This thesis is approved, and it is acceptable in quality and form for publication:

Approved by the Thesis Committee:

Dr. Rafiqul A. Tarefder, Chairperson

Dr. John C. Stormont

Dr. Guohui Zhang

**ANALYTICAL MODELING OF RUTTING POTENTIAL OF
ASPHALT MIXES USING HAMBURG WHEEL TRACKING
DEVICE**

by

MATIAS MARIO MENDEZ LARRAIN

THESIS

Submitted in Partial Fulfillment of the
Requirements for the Degree of

**Master of Science
Civil Engineering**

The University of New Mexico
Albuquerque, New Mexico

November 2015

ACKNOWLEDGEMENTS

Firstly, I would like to express my sincere gratitude to my advisor Prof. Rafiqul Tarefder for the continuous support of my master's study and related research, for his patience, motivation, and immense knowledge. His guidance helped me in all the time of research and writing of this thesis. I also would like to thank the members of my committee, Dr. John Stormont and Dr. Gouhui Zhang for their valuable time.

I would like to acknowledge the New Mexico Department of Transportation Research Bureau for project funding and equipment used in this study. I specifically would like to express my thankfulness to the members: Mr. Virgil Valdez, Mr. Parveez Anwar and Mr. James Gallegos.

I appreciate the continuous supports of Asifur Rahman and Mohiuddin Ahmad in laboratory and project works. Orientation of Sherif Aboubakr in my thesis writing and format is greatly acknowledged. I also would like to thank all my research group members for their inspiration.

Last but not the least; I would like to thank my beloved parents and sisters, my cousin Edwin Villarroel, Vania Carvajal, my family and friends for supporting me spiritually throughout writing this thesis and my life in general.

ANALYTICAL MODELING OF RUTTING POTENTIAL OF ASPHALT MIXES USING HAMBURG WHEEL TRACKING DEVICE

by Matias Mario Mendez Larrain

B.Sc. Civil Engineering, Private University of Bolivia, 2011

M.Sc. Civil Engineering, University of New Mexico, 2015

ABSTRACT

Asphalt Concrete (AC) is susceptible to permanent deformation under traffic loading which is affected by AC temperature, mixture type, gradation, aggregate type, binder type and so on. There is no complete research in the literature which examined all these factors at the same time. This study evaluated the above mentioned factors in the deformation behavior of AC. Thin AC cylindrical samples were prepared using 20 different AC mixtures collected from different construction sites in New Mexico (NM). As a first step, effects of test temperatures, type of aggregate, binder grade, type of mixture and gradation on the permanent deformation of AC were investigated using the Hamburg Wheel Tracking Device (HWTDD). Secondly, the deformation behavior of the AC (obtained from the HWTDD) was modeled using the Weibull function. Results show, the deformations of AC are sensitive to test temperatures, type of mixture, gradation, type of aggregate and binder type (Analysis shows that test results significantly vary with studied parameters). In addition, the effect of air void contents was studied showing insignificant sensitivity for the studied parameters. Finally, the rutting behavior of AC mixtures under the different conditions mentioned above promisingly correlated with the Weibull function.

TABLE OF CONTENTS

ACKNOWLEDGEMENTS.....	iii
ABSTRACT.....	iv
Chapter 1 INTRODUCTION.....	1
1.1 Background.....	1
1.2 Objectives	2
1.3 Thesis Outline.....	3
Chapter 2 LITERATURE REVIEW.....	5
2.1 General.....	5
2.2 Permanent Deformation.....	5
2.2.1 Effect of Properties in Permanent Deformation.....	7
2.3 Moisture Damage.....	8
2.3.1 Moisture Damage Mechanism.....	9
2.3.2 Moisture Damage Susceptibility Factors.....	11
2.4 Hamburg Wheel Tracking Device	12
2.4.1 Procedure and Results.....	15
2.4.2 Standard Test	17
2.4.3 Effect of Test Temperature in HWTD.....	19
2.4.4 Effect of Aggregate in HWTD.....	21
2.4.5 Anti-stripping Agents and HWTD.....	21
2.4.6 HWTD Related to Field Performance.....	23
2.4.7 Gradation and Air Voids Effect.....	24
2.4.8 Warm Mix Asphalt Agents Effect	25

2.4.9 Weibull Function	27
Chapter 3 MATERIALS & EXPERIMENTAL METHODOLOGY	30
3.1 General.....	30
3.2 Material Source and Classification.....	30
3.2.1 Material Collection	30
3.2.2 HMA/WMA Mixtures Collection.....	31
3.3 Specimen Preparation and Compaction.....	35
3.3.1 Sample Size.....	35
3.3.2 Theoretical Maximum Specific Gravity (G_{mm}).....	36
3.3.3 Sample Compaction.....	37
3.3.4 Air Voids Contents	40
3.3.5 Final Details.....	43
3.4 Experimental Program	44
3.4.1 Deformation Measurement Techniques.....	44
3.5 Test Matrix.....	46
Chapter 4 PARAMETER EFFECT IN HAMBURG WHEEL TRACKING DEVICE	48
4.1 General.....	48
4.2 Type of Mixture Effect	55
4.2.1 Type of Mixture and Gradation	61
4.2.2 Type of Mixture and Type of Aggregate	64
4.2.3 Type of Mixture and Binder Performance Grade	66
4.3 Type of Gradation Effect	69
4.3.1 Type of Gradation and Type of Aggregate.....	75

4.3.2 Type of Gradation and Binder Performance Grade	78
4.4 Type of Aggregate	80
4.5 Type of Binder Performance Grade	88
Chapter 5 WEIBULL MODEL.....	96
5.1 General.....	96
5.2 Type of Mixture Weibull Parameters	100
5.3 Type of Gradation Weibull Parameters	102
5.4 Type of Aggregate Weibull Parameters.....	104
5.5 Type of Binder Performance Grade Weibull Parameters	108
5.6 Predicted Rutting and Model Fitting.....	112
Chapter 6 CONCLUSIONS AND RECOMMENDATIONS.....	119
6.1 Conclusions.....	119
6.2 Recommendations.....	121
REFERENCES	122
APPENDIX.....	128

LIST OF FIGURES

Figure 2.1 Permanent deformation distress	6
Figure 2.2 Permanent Deformation in an asphalt concrete layer.....	8
Figure 2.3 Moisture damage in asphalt concrete	9
Figure 2.4 The University of New Mexico HWTD	12
Figure 2.5 Close-up HWTD.....	13
Figure 2.6 HDPS mold for cylindrical specimens (6).....	14
Figure 2.7 HWTD result curve	16
Figure 2.8 Shape parameter (β) curve.....	28
Figure 3.1 Collection and storage of material.....	31
Figure 3.2 Mixtures gradation according the maximum density line	35
Figure 3.3 Maximum theoretical specific gravity procedure.....	36
Figure 3.4 Sample compaction	40
Figure 3.5 Bulk specific gravity procedure.....	42
Figure 3.6 Final product.....	43
Figure 3.7 Deformation measurement LVDT's configuration	45
Figure 4.1 HMA/WMA Maximum Impression Vs Maximum Wheel Passes at (a) 40 °C (b) 60 °C (c) 50 °C.....	55
Figure 4.2 HMA/WMA Post-Compaction Slope due temperature test.....	57
Figure 4.3 HMA/WMA Creep Slope due temperature test	58
Figure 4.4 HMA/WMA Stripping Slope due Temperature Test	59
Figure 4.5 HMA/WMA Maximum Rutting Depth according to AV contents (a) 0 – 20 mm. scale (b) 0 – 9 mm. scale.....	60

Figure 4.6 Type of Mixture and Gradation HWTD results due test temperature	62
Figure 4.7 HMA/WMA and Type of Aggregate HWTD results at 50 °C	65
Figure 4.8 HMA/WMA and Binder PG HWTD Results at 50 °C	67
Figure 4.9 Type of Gradation Maximum Impression Vs Maximum Wheel Passes at	69
Figure 4.10 Type of Gradation Post-Compaction Slope due temperature test	71
Figure 4.11 Type of Gradation Creep Slope due temperature test	72
Figure 4.12 Type of Gradation Stripping Slope due temperature test	73
Figure 4.13 HMA/WMA Maximum Rutting Depth According to AV Contents (a) 0 – 20 mm. scale (b) 0 – 9 mm. scale	74
Figure 4.14 Type of Gradation and Type of Aggregate HWTD Results at 50 °C	77
Figure 4.15 Type of Gradation and Binder PG HWTD Results at 50 °C	79
Figure 4.16 Type of Aggregate Maximum Impression Vs Maximum Wheel Passes at	81
Figure 4.17 Type of Aggregate Post-Compaction Slope due Temperature Test	83
Figure 4.18 Type of Aggregate Creep Slope due temperature test	84
Figure 4.19 Type of Aggregate Stripping Slope due Temperature Test	85
Figure 4.20 Type of Aggregate Maximum Rutting Depth According to AV contents (a) 40 °C (b) 50 °C (c) 60 °C	87
Figure 4.21 Type of Binder Performance Grade Maximum Impression Vs Maximum Wheel Passes at (a) 40 °C (b) 50 °C (c) 60 °C	90
Figure 4.22 Type of Binder PG Post-Compaction Slope due Temperature Test	91
Figure 4.23 Type of Binder PG Creep Slope due temperature test	92
Figure 4.24 Type of Binder PG Stripping Slope due temperature test	93
Figure 4.25 Type of Binder PG Maximum Rutting Depth According to AV contents	95

Figure 5.1 Shape and Scale parameters for WMA mixtures	100
Figure 5.2 Shape and Scale parameters for HMA mixtures	101
Figure 5.3 Shape and Scale parameters for finer mixtures	102
Figure 5.4 Shape and Scale parameters for coarser mixtures	103
Figure 5.5 Shape and Scale parameters for basalt aggregate.....	105
Figure 5.6 Shape and Scale parameters for limestone aggregate.....	106
Figure 5.7 Shape and Scale parameters for sand and gravel aggregate.....	107
Figure 5.8 Shape and Scale parameters for river deposits aggregate	108
Figure 5.9 Shape and Scale parameters for PG64-28	109
Figure 5.10 Shape and Scale parameters for PG70-22	110
Figure 5.11 Shape and Scale parameters for PG76-22	111
Figure 5.12 HWTD Rutting modeled Eq. 8 for mixture 1	114
Figure 5.13 HWTD Rutting modeled Eq. 8 for mixture 4.....	115
Figure 5.14 HWTD Rutting modeled Eq. 8 for mixture 12.....	116
Figure 5.15 HWTD Rutting modeled Eq. 8 for mixture 15.....	117
Figure 5.16 HWTD Rutting modeled Eq. 8 for mixture 18.....	118

LIST OF TABLES

Table 2.1 HWTD Test Conditions and Limits Used by Transportation Agencies (25)	18
Table 2.2 Summary of AC HWTD Results in Presences of WMA Agents	26
Table 3.1 Materials Collected	32
Table 3.2 Mixtures Gradation	33
Table 3.3 HWTD Test Matrix	47
Table 4.1 HWTD Results	49
Table 4.2 HMA/WMA Gradation Test in Presence of Stripping	63
Table 4.3 Type of Mixture and Type of Aggregate HWTD Matrix	64
Table 4.4 Type of Mixture and Type of Binder PG HWTD Matrix	66
Table 4.5 Type of Gradation and Type of Aggregate HWTD Matrix	76
Table 4.6 Type of Mixture and Type of Binder PG HWTD Matrix	78
Table 5.1 AC Mixtures Weibull Parameters	97
Table 5.2 Shape and Scale Parameters for Quartzite Aggregate	104
Table 5.3 Shape and Scale Parameters for PG76-22 and Modified Polymer	108
Table 5.4 Predicted Shape and Scale Parameters for AC Mixtures at 50 °C	113

Chapter 1 INTRODUCTION

1.1 BACKGROUND

Different laboratory destructive and non-destructive tests have been used by state highways agencies to determine the effect of mix parameters in the performance of hot and warm mix asphalts. The Hamburg Wheel Tracking Device (HWTD) test is a destructive test method that determines the resisting rutting and moisture damage (stripping) of a certain Asphalt Concrete (AC) while a steel wheel rolls across an asphalt concrete surface in a hot water bath. HWTD was introduced into the United States from Germany in the early 1990s by a group of individuals representing different transportation agencies (1). Throughout many years, the use of HWTD in laboratory testing for moisture and rutting susceptibility has been extensively evaluated by some transportation agencies. In general, many of the departments of transportation adopt the Tensile Strength Ratio (TSR) as an indicator of the moisture damage in Asphalt Concrete (AC) surfaces. As a potential substitute for the TSR test in the near future, HWTD test needs to be analyzed as moisture damage indicator and more research is needed to verify its effectiveness on a broader range of material types and field conditions. Test and mixture parameters such as water temperature, Air Void (AV) contents, type of mixture, type of aggregate, type of binder Performance Grade (PG), gradation and anti-stripping additives have a significant effect on the durability of AC. Previous mentioned parameters lead to observe a weak aggregate structure, inadequate binder stiffness, moisture damage and an inadequate binder to aggregate adhesion that increases the susceptibility of a premature failure in Hot Mix Asphalt/Warm Mix Asphalt (HMA/WMA). Moisture damage is responsible for million dollars in maintenance and reconstruction of asphalt surfaces in the United States. The use of anti-stripping agents in

HMA/WMA mixtures contribute to avoid the moisture damage, highways state agencies tends to use hydrated lime, liquid additives and other technologies to reduce this serious problem damaging asphalt pavements in the United States for several decades. HWTD results shown to be an alternative to evaluate moisture damage but results must be related to field performance. Aschenbrener et al. (2) showed a good correlation between laboratory samples and field performance for stripping. The plastic deformation in asphalt caused by an external loading is named rutting, and a significant rutting depth is an equivalent of pavement failure. Rut resistance in the HWTD test can be obtained by tracking the deformation when a loaded wheel passes through a compacted asphalt mixture. Results are expressed in rutting depth (mm) and represent the permanent deformation of certain asphalt mixture at different number of load cycles. Some departments of transportation have implemented HWTD as a specification to observe the rutting and stripping resistance of asphalt mixtures. Susceptibilities of rutting and moisture are based on a pass/ fail criteria differing for each of the state agencies. Pass and fail test criteria depends mostly in the performance grade of the asphalt mixture. Test water temperature and the number of loading cycles of the test as are defined for each binder PG along with the maximum rutting depth.

1.2 OBJECTIVES

The primary objective of this study is to:

- Evaluate the effect of binder PG, type of aggregate, type of mixture and gradation on rutting using HWTD.
- Evaluate the effect of HWTD test temperature and air void contents in the studied parameters.
- Model rutting distresses using Weibull function.

To fulfill these objectives, more specific tasks include the following:

1. Collect HMA/WMA mixtures with different type of aggregate, binder type and WMA agents in bulk condition among the six districts of the state of New Mexico following the standard AASHTO T 168-11 (3).
2. Determine the Theoretical Maximum Specific Gravity (G_{mm}) according AASHTO T 209-11 (4) standard for each mixture.
3. Compact AC cylindrical samples in the Superpave Gyrotory Compactor (SGC) following AASHTO T 312-11 (5) with a specific AV contents range and geometrical restraints according AASHTO T 324-11 (6) standard.
4. Determine the Bulk Specific Gravity (G_{mb}) according AASHTO T 166-11 (7) standard and determine the specific air void content of each cylindrical sample.
5. Conduct HWTD test at different water bath temperatures for each of the HMA/WMA mixtures according AASHTO T 324-11 (6) standard.
6. Determine and compare the different HWTD test results when type of mixture, type of aggregate, binder PG, and gradation. Develop a model to understand rutting in AC mixtures due defined parameters variation.

1.3 THESIS OUTLINE

Following the background and objectives of this study discussed in Chapter 1. Chapter 2 is a technical literature review focused on previous research relevant to the scope of this thesis. Emphasis is placed on the test configuration, rutting, moisture damage, mixture parameters effect and modeling. Chapter 3 introduces the reader to the materials used in this study, including engineering properties of HMA/WMA mixtures (such as type of aggregate, binder PG, WMA technology, etc.). This chapter also includes sample preparation and laboratory test procedures

and the respective results. Hamburg wheel tracking device results for different type of mixes are presented in Chapter 4. Results are presented in tabular and graphical forms with the respective analysis. In addition, a model to predict rutting depth is developed in Chapter 5. Chapter 6 summarizes the findings and culminates with conclusions and recommendations of this study.

Chapter 2 LITERATURE REVIEW

2.1 GENERAL

In general, AC pavements are constructed with different type of aggregates, binder types, anti-stripping agents and technologies. HMA/WMA mixtures are compacted at high or low temperatures to reach the specified density. Due environmental influence and repeated traffic loading, AC pavements decay once they are under traffic stresses.

This chapter provides an overview of laboratory procedure of HWTD test and the different findings by different researchers. A brief discussion of permanent deformation (rutting) and moisture damage concepts and associated issues that can influence the laboratory test results for the different type of mixes are presented at the beginning because of their relevance to the present study. In addition, the applications of Weibull model in different fields of pavement engineering are presented.

2.2 PERMANENT DEFORMATION

Permanent deformation (rutting) in asphalt concrete pavements manifest itself as longitudinal depression in the wheel paths (8) where traffic fluctuates. The unrecoverable cumulative deformation that occurs in the wheel path under high temperatures as result of the traffic loading is named permanent deformation or rutting ash shown in Figure 2.1.

The stress applied by the traffic loading moves AC at the sides pushing out from the loaded area. The depression is mostly due to compaction while the lateral movement happens as a result of the shear failure.



Figure 2.1 Permanent deformation distress

Difficulty at the time of steering the wheel is a problem caused by permanent deformation. In addition, plumbing effect is more susceptible when this distress occurs. Rutting mostly occurs in hot areas and where traffic moves slow. Aging and densification happens through years reducing the rut effect on AC pavements, so rutting damage tends to occur in the first years of the pavement life. Generally three are the causes of rutting in asphalt pavements: accumulation of permanent deformation in the asphalt layer, permanent deformation in the subgrade and wear of pavement caused by studded tires (9).

There are several factors that influence the behavior of permanent deformation in an asphalt concrete layer. Mixture design, compaction, loading and temperature affects the stiffness and resistance of a mixture for rutting distresses. Wheel contact pressure produces a non-uniform vertical, longitudinal and lateral contact stresses in AC layer. Muraya (10) states that contact stresses are a function of tire pressure, wheel load, type of tire and pavement surface.

2.2.1 Effect of Properties in Permanent Deformation

The combination effect in the properties of the aggregate and asphalt in a defined mixture are the ones who contribute to avoid rutting in the pavements and understand the behavior of this distress. Asphalt concrete is composed of aggregates, asphalt and AV. Researchers found that the proportion of each of these properties have a significant impact in the rutting deformation.

2.2.1.1 Aggregate

Type of aggregate play an important role in AC pavements due the fundamentality to avoid rutting. Roughness and angularity are key parameters for the aggregates to behave well and avoid rutting. Aggregates with rough surface textures and angular sides rather than rounded shapes show improved rutting resistance (11). Crushed aggregates are better than natural gravels. Hardness of the material is also an important indicator of rutting, hard materials experience less permanent deformation.

2.2.1.2 Asphalt mixture

The content of aggregates, asphalt and AV contents are important parameters to understand the rutting behavior of AC pavements under traffic stresses. Stiffness is an indicator of rut resistance. Stiffer materials showed better permanent deformation results in AC. In addition, asphalt content used in a mixture is related to rutting. High asphalt content derives in significant rutting distresses. The coefficient of thermal expansion of the binder is approximately an order of magnitude higher than the aggregate (12). High temperatures and high asphalt content in a mixture have significant rutting distresses. Otherwise, lower asphalt content in the mixture has an impact in the compaction process and AV contents. High AV contents in the mixture and low asphalt content implicate low durability and high fatigue cracking. In summary, optimum asphalt content and target AV contents are necessary to improve performance in terms of permanent

deformation in AC pavements. A high permanent deformation and a weak AC layer are shown in Figure 2.2.

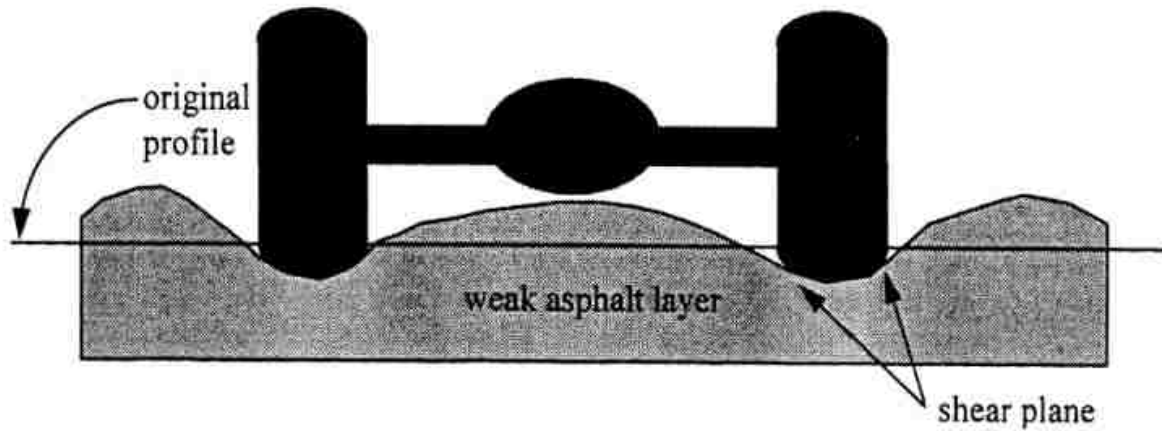

Figure 2.2 Permanent Deformation in an asphalt concrete layer

The objective to have an asphalt mixture design is to define the optimum contents of asphalt and aggregates that would produce an economical mixture and the following findings:

- Adequate binder content to guarantee durability
- Adequate air void content to obtain a good compaction and avoid bleeding
- Adequate workability to permit commit with the constructive process

2.3 MOISTURE DAMAGE

Moisture damage can be understood as the progressive deterioration of asphalt mixes by loss of adhesion between asphalt binder and aggregate surface and/or loss of cohesion within the binder primarily due to the action of water (13). The progressive deterioration of asphalt mixes by loss of adhesion and loss of cohesion is named moisture damage; the first condition for moisture damage is the presence of moisture in the asphalt mixture during traffic loading. States highway agencies observed closely to this issue since roadways are being affected. The use of anti-stripping agents and technologies showed benefits to avoid this problem. Anyhow, roadways still

suffer this problematic issue who contributes all the modes of distresses in pavements like rutting, thermal cracking and fatigue cracking. Santucci (14) shown that stiffness or strength is recovered when water is removed from the mixture, anyhow if pavement is under load during the weakened condition damage may be accelerated and become irreversible.



Figure 2.3 Moisture damage in asphalt concrete

2.3.1 Moisture Damage Mechanism

Moisture damage occurs when several factors like the type of mixture, material properties, drainage, traffic loading and environmental characteristics interacts in the asphalt concrete layer. Air void contents is a critical parameter for moisture damage, dense-graded mixes are typically designed at four percent air void content but the actual air void content is between 6 and 10 percent. Terrel and Al-Swailmi (15) described as critical behavior when AV contents are higher than 8 percent which is non-recommendable. Interconnection and moisture can flow easily if AV contents exceed the 8 percent. Otherwise, air voids are disconnected and are relatively impermeable. In critical AV contents, water easily penetrates the voids but cannot escape freely.

To take effective measures to understand moisture damage, an understanding of the chemical and mechanical mechanism is needed. Moisture damage mechanism is also related to other damage mechanism like loss of cohesion, loss of adhesion, pore pressure and hydraulic scouring.

2.3.1.1 Loss of cohesion

The molecular attraction between particles united throughout the mass is named cohesion; in asphalt engineering cohesion is the entire integrity of the materials under stresses. The loss of cohesion happens when the asphalt cement gets softer in the presence of water and reduces the tensile strength of the mixture; the bond between the asphalt cement and the aggregates gets weak. Loss of cohesion may lead to weaken the pavement and it became susceptible to premature cracking and pore pressure damage. The process of stripping is affected when cohesion is being reduced; a significant reduction in stiffness and strength is observed (16). Many state transportation agencies have implemented the use of anti-stripping agents in AC mixtures to avoid this damage mechanism.

2.3.1.2 Loss of adhesion

The loss of adhesion is the physically separation of the asphalt cement and the aggregate caused by the action of moisture. Adhesion may be achieved mechanically and chemically. Mechanically adhesion totally depends on the physical properties of the aggregate such as texture, surface area, particle size and porosity. Rough materials absorbs asphalt and the largest the surface area the better mechanical interlock. One peculiar consequent phenomenon of loss of adhesion is stripping since aggregates get exposed.

Adhesion behavior may be affect by the following factors (17):

- Chemical composition of the asphalt and aggregates
- Asphalt viscosity

- Surface tension of the asphalt cement and aggregates
- Surface texture of aggregates
- Porosity of the aggregates
- Aggregates moisture content and temperature at time of mixing

2.3.1.3 Pore pressure and hydraulic scouring

Moisture damage can lead to have pore pressure and hydraulic scouring in asphalt mixtures. When water or moisture is entrapped in the AC mixture can lead to high internal stresses due traffic loading, this internal stress is called pore pressure. Pore pressure also accelerates the diffusion of water inside the asphalt films (13). In the other hand, hydraulic scouring tends to occur when water remains trapped for long time in the surface of the layer and in the interface between lifts and the asphalt concrete. When the surfaces are under the presence of water tire pressure applies load and then suction in the surface pores, this compression and tension behavior contributes stripping.

2.3.2 Moisture Damage Susceptibility Factors

There are many factors that affect moisture damage and increase its harmful capacity to asphalt concrete pavements (18). In aggregates, coarse and fine must be examined carefully in evaluating the water damage of the mixture. Some aggregates like gravel and other siliceous type are sensitive to moisture and tends to strip more when are attached to asphalt cement. In the other hand, previous research showed that limestone aggregate is less susceptible to moisture. Stripping takes place mostly in the finer aggregate. Source of the asphalt cement may be a factor but is less dominant than aggregate.

Asphalt concrete mixture properties are critical to avoid moisture damage. The AV contents play an important role for this factor since this parameter is sensitive to moisture damage. Degree of

compaction, type of aggregate and asphalt cement are important to control the AV content in the AC mixture. High AV contents may result in a considerable degree of moisture damage.

Thickness of the film in the asphalt layer has impact on moisture damage since affects the durability of the mix. Ebrahim and Behery (18) stated that AC mixtures with thick asphalt films are less susceptible to moisture damage.

The environmental conditions as long as the traffic also contribute to stripping in the mixtures; moisture damage tends to occur mostly in areas where the amount of rain and snow is considerable, temperatures are high and traffic is heavy.

2.4 HAMBURG WHEEL TRACKING DEVICE

Hamburg wheel tracking device test (Figure 2.4 and Figure 2.5) was introduced into the United States from Germany in the early 1990's by a group of individuals representing different transportation agencies (19). The HWTD test was originally designed for measuring rutting behavior; later on, was found that this test was capable to evaluate the potential moisture resistance of AC mixtures.



Figure 2.4 The University of New Mexico HWTD



Figure 2.5 Close-up HWT

Hamburg wheel tracking device measures the combined effects of permanent deformation (rutting) and moisture damage (stripping) by rolling a steel wheel across the surface of a compacted AC mixture that is submerged in hot water. Test is performed using compacted cubical slabs, cylindrical specimens and field cores. Cubical samples are usually compacted in a linear kneading compactor. Cylindrical samples were found to be simple and more convenient than the use of cubical slabs since plaster is needed for most of this type of specimens (20). Cylindrical samples are commonly compacted in the Superpave Gyratory Compactor (SGC). Generally, four cylindrical specimens with a 62 ± 1 mm. (2.4 in.) height and a 150 mm. (6 in.) diameter are submerged in a water bath at $50\text{ }^{\circ}\text{C}$ ($122\text{ }^{\circ}\text{F}$). Two 158 lb. (702 N) wheels roll at approximately 52 Revolutions per Minute (RPM) over two connected cylindrical samples. Each set of specimens is tested at 20,000 wheel load cycles or until 12.5 mm. (0.5 in.) deformation is reached (21). Some state agencies increased the maximum deformation criteria for research purposes. Hamburg wheel tracking device test is conducted following the AASHTO T 324-11 (6) test standard. Rut depth at the specimen surface is measured by a Linear Variable Displacement Transducer (LVDT) on each wheel with a range of measurement of deformation 0

to 30 and a precision of ± 0.01 mm. Measurements are taken along the length of the specimens at 11 equally spaced points, including the center point (joint between cylindrical specimens). The machine is capable of running any number of cycles (up to 200,000) specified and ending when the number of cycles is reached or when an operator-specified amount of deformation is reached. Normally the test is run to 20,000 cycles or when 0.5 in. deformation is reached, whichever comes first. Approximately maximum nine hours are required for a test. Studies concluded that HWTD results are sensitive to quality of aggregate, asphalt cement stiffness, length of short-term aging, refining process, liquid and hydrated lime, and compaction temperature (22).

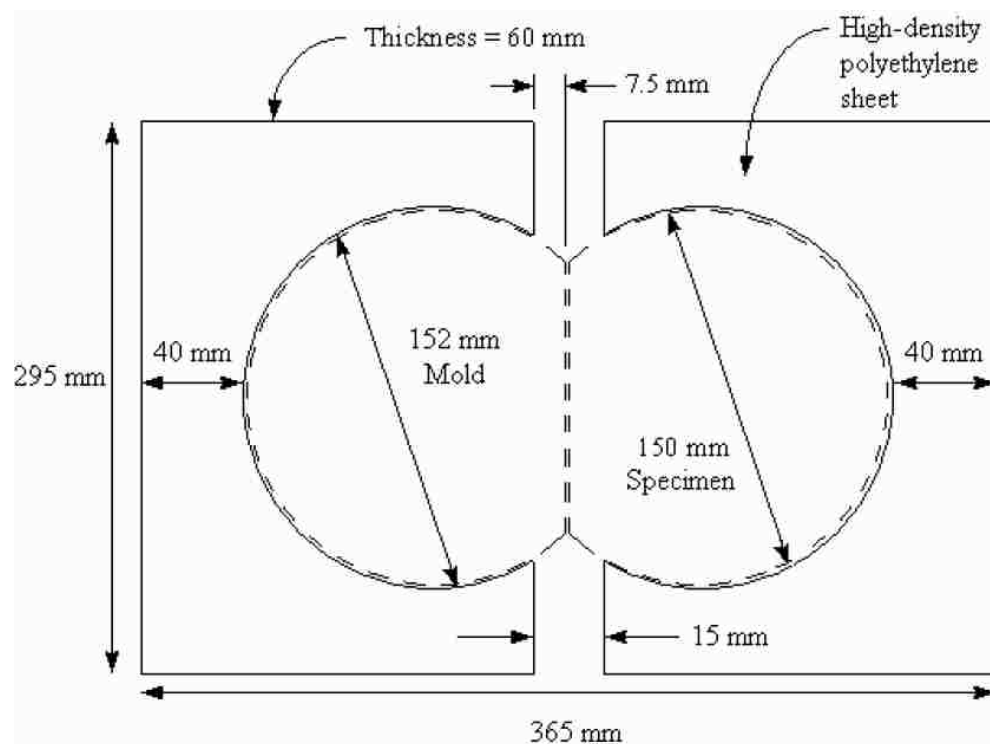

Figure 2.6 HDPS mold for cylindrical specimens (6)

2.4.1 Procedure and Results

The procedure for the HWTD test is described in the AASHTO T 324-11 (6). The scope of this standard includes only the test method used to determine the premature failure susceptibility of HMA/WMA due to weakness in the aggregate structure, inadequate binder stiffness, or moisture damage. This is not a binder test and, in fact, two HMA/WMA specimens with the same binder content, PG and source could perform differently under the HWTD test. Non uniform compaction of the mixture, angularity of the fine or coarse aggregates, and fines coating the aggregates have been found to affect negatively the mixture performance in the HWTD test.

Hamburg wheel tracking device test measures the rut depth and number of passes to failure. In addition, it describes the procedure for testing rutting and moisture susceptibility of HMA/WMA Asphalt concrete samples in the HWTD. Results are expressed in post-compaction consolidation, creep slope, stripping inflection point and stripping slope shown in Figure 2.7. The post-compaction consolidation is the rut depth at the first 1,000 wheel passes and occurs at the very beginning of the test. It is called post-compaction consolidation because the load applied by the wheel increase the density of an asphalt mixture. The creep slope is related to the permanent deformation (rutting) of the asphalt mixture. It is the inverse of the rate of deformation in the linear region of the deformation curve, after post compaction and before stripping (23). The stripping slope is related to the moisture damage (stripping) of an asphalt mixture. It is the inverse of the rate of deformation in the linear region of the deformation curve, after starting stripping to the end of the test. It is the number of passes required to create a 1 mm impression from stripping (23). The lower the creep slope and the stripping slope the most severe rutting and moisture damage the mixture experiences. The Stripping Inflection Point (SIP) is the number of wheel passes that intersects the creep slope and the stripping slope. This mark is related to the

resistance of the asphalt mixture to moisture damage. Once the stripping inflection is reached, moisture damage starts to dominate the performance of the mixture.

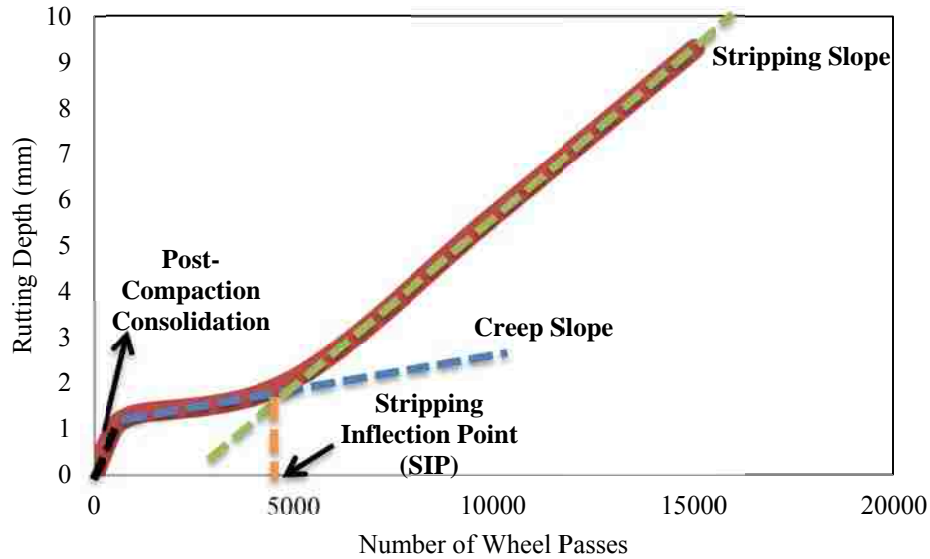

Figure 2.7 HWTD result curve

The shape of the curve in Figure 2.7 is the same as creep and repeated load tests which determines the typical permanent deformation curve. The tertiary region is related to moisture damage and is when the samples tend to fail rapidly. Based on the examination of many slabs and pavement cores, the tertiary regions of the curves produced by the HWTD appear to be primarily related to moisture damage, rather than to other mechanisms that cause permanent deformation, such as viscous flow (24). Yildirim (24) states that mixtures that are susceptible to moisture damage tend to start losing fine aggregates around the stripping inflection point, and coarse aggregate particles may become dislodged.

The data reported includes the number of passes, maximum impression, test temperature, sample AV contents, post-compaction point, creep slope, stripping slope and stripping inflection point.

2.4.2 Standard Test

There is not a defined standard configuration for HWTD test. AASHTO T324 only address the preparation of cylindrical samples but configuration of the test is not defined. Configuration inputs and sample parameters will affect the results of the HWTD. Variation of test temperature, conditioning time, loading and frequency of loading are configuration that will change results of the test. The most common setup for HWTD used for most of the transportation agencies are the following:

- 20,000 passes along the test
- 12.5 mm. (0.5 in) maximum rutting depth (pass)
- 52 rpm
- 50 °C water bath temperature
- 158 lb. (700 N approx.)

Several departments of transportation have implemented HWTD test in their specifications as an alternative to Tensile Strength Ratio (TSR) test. Researchers found that binder PG is related to HWTD, stiffer asphalt binder showed better results. In their specification, transportation agencies defined the water temperature test and number of passes according to the binder PG grade of the AC mixture. In addition, a maximum rutting depth was adopted when binder PG varies.

The following table shows the different criteria that some department of transportation adopt for this test:

Table 2.1 HWTD Test Conditions and Limits Used by Transportation Agencies (25)

Department of transportation	PG Grade	Number of wheel passes	Test Temperature (°C)	Maximum rut depth		Comments
				mm.	in.	
California	PG58-XX	10,000	50	12.7	0.5	WMA technology tested at 50 °C
	PG64-XX		55			
	PG70 and Higher		60			
Colorado	PG58-XX	10,000	46	4	0.16	Test and limits are used for research only
	PG64-XX		50			
	PG70-XX		55			
	PG76-XX		60			
Illinois	PG58-XX	5,000	50	12.5	0.5	N/A
	PG64-XX	7,500				
	PG70-XX	15,000				
	PG76-XX	20,000				
Iowa	PG58-XX	20,000	50	N/A	N/A	SIP evaluated only for moisture sensitivity purposes
	PG64-XX					
	PG70-XX					
Kansas	N/A	10,000	50	12.5	0.5	N/A
Louisiana	PG70-22 (Level 1)	20,000	50	10	0.39	N/A
	PG76-22 (Level 2)			6	0.24	
Montana	PG58-28	Plant mix: 10,000 Mix desing: 15,000	44	13	0.5	Specified temperature is 14 °C below the the avarage 7 day maximum pavement temperature design
	PG64-XX		50			
	PG70-28		56			
Oklahoma	PG64-XX	10,000	50	12.5	0.5	N/A
	PG70-XX	15,000				
	PG76-XX	20,000				
Texas	PG64-XX	10,000	50	12.5	0.5	N/A
	PG70-XX	15,000				
	PG76-XX	20,000				
Utah	PG58-XX	20,000	46	10	0.4	N/A
	PG64-XX		50			
	PG70-XX		54			

Level 1: Low traffic, Average Daily Traffic (ADT) < 7000 Level 2: High traffic, (ADT) > 7000

The city of Hamburg is more conservative than American transportation agencies, Hamburg defined to have less than 4 mm. rut depth after the 20,000 wheel passes. Colorado Department of Transportation (CDOT) changed its conditions reducing the number of passes but decreasing the maximum rutting depth more than 50 percent. In the past CDOT define 10 mm. rut depth after 20,000 passes. Anyways, CDOT is the most conservative department of transportation in terms of HWTD test. In conclusion, transportation agencies defined the test conditions either varying

the number of wheel passes run depending on the high-temperature binder grade (PG) (for a given test temperature), or varying the test temperature depending on the high-temperature binder grade (PG) (for a given maximum number of wheel passes run). The HWTD test passing/not passing limits in terms of maximum rut depth, stripping inflection point (SIP) and stripping slope also vary among the different departments of transportation (25). The sensitivity of HWTD test clearly depends on test configurations and mixture properties. Aschebrenner (26) found that quality of aggregate, asphalt cement stiffness, short-term aging duration, refining process, use of liquid anti-stripping agents, hydrated lime additives, and compaction temperature have impact in the results using HWTD. Predict how compacted mixtures will behave under HWTD is variable due previous parameters mentioned.

2.4.3 Effect of Test Temperature in HWTD

Temperature in asphalt science is related to the binder PG. PG is a system based on two numbers affined to high and low temperature in degrees Celsius. For example, a PG XX-YY would be used in an environment where one would expect the surface temperature of the road to experience a high temperature up to XX °C and a low of down to minus YY °C. New Mexico department of transportation approve the following performance graded binders.

- PG 58-28
- PG 64-22
- PG 64-28
- PG 70-22
- PG 70-28
- PG76-22
- PG 76-28

- PG 70-28+ (for open graded friction course only)
- PG 70-28R+ (for open graded friction course only)

As mentioned before, the most commonly used test temperature to perform the HWTD test by state and federal agencies is 50 °C. According to Aschenbrener (19) this temperature is a standard temperature to perform HWTD for all binder performance grades. Mixtures with higher binder PG accumulates less deformation than those with lower grade binders, this clearly indicates that there is a significant effect of test temperature and binder type on the HWTD test (27). In other words, as the test temperature increases, the average permanent deformation increases accordingly. Otherwise, Nielson (28) observed that test temperature for some PG grade binders performs different; increasing the temperature test do not always reduce the stripping inflection point. Nielson defined a term named critical stripping temperature (CST) where below that temperature test stripping would not be observed. Since the environmental zones for all different states are not constant different criteria's of HWTD test were set. As shown in Table 2.1, every state has different assumptions at the time to choose the test criteria. Binder performance grade is the most significant input to define the number of wheel passes and water temperature for HWTD test. Yildirim and Stokoe (29) compared the average deformation for samples that passed the test against binder type. This comparison leads to conclude two important assumptions for HWTD test related to test temperature. First, as the test temperature increases, the average deformation increases. Second, higher PG grades accumulate less deformation than those with lower PG grades. These two assumptions clearly indicate the significant effect of test temperature and binder type for this test. Finally, compaction temperature significantly influences the results from the HWTD. The higher the compaction temperature, the better results in terms of rutting depth (19). Gogula et al. (30) showed the

variability on HWTD results when different Performance Grade (PG) binder grades and Air Voids (AV) contents are present. PG 52-28, PG 64-22, PG 58-28, and PG 70-28 were studied and the mixture with PG 70-28 performed better than the mixtures with any other binder type. In addition, their study showed that mixtures with lower AV performed better.

2.4.4 Effect of Aggregate in HWTD

Aggregates have become important on the performance of asphalt mixtures since most of it are composed with different type of aggregates. Aggregate mineralogy and durability properties are keys to determine the influence of aggregates in HWTD test. Aggregate type is closely related to permanent deformation (rutting) since its composition influences the behavior of this distress. The interplay between aggregates type, binder type and temperature are significant properties to increase the susceptibility to rutting. Otherwise, the aggregate properties such as particle shape, angularity and texture also play an important role. Understand the effect of aggregate is difficult to quantify since any aggregate properties will differ the results. In terms of degradation, limestone aggregates shows higher level of degradation and lower levels of stripping different than gravel aggregates. The correlation between HWTD and Los Angeles abrasion test showed good results (31), harder aggregates tend to perform better in the HWTD test.

2.4.5 Anti-stripping Agents and HWTD

The use of anti-stripping agents in AC mixtures has become useful to several transportation agencies to avoid moisture damage (27). The use of additives such as anti-stripping agents changes the binder properties in addition to the intended modification; it proved resistance against moisture damage. It is believed the stripping potential of asphalt mixtures is potentially reduced with the use of anti-stripping agents. New Mexico department of transportation uses hydrated lime and Versabind as potential anti-stripping additives in their AC mixtures. A

comparison between hydrated lime and liquid anti-stripping agents was made by some researches; they found that hydrated lime has better results than liquid anti-stripping agents in terms of HWTD results (13). In addition, Lu (13) observed that effectiveness of hydrated lime does not decrease, but instead in some cases increases with conditioning time, while the effectiveness of the liquid anti-stripping agents generally does not change with time. It was also found that percentage content of anti-stripping agent it is not related to performance, if additives are used incorrectly or when not needed adverse effects may occur and maintenance may be needed early than expected. Higher anti-stripping content in the mixture can result in worse results since these agents affect the deformation characteristics of the mixture.

Anyways, the amount of anti-stripping agent is also related to gradation of the aggregate. Usually a 1 to 1.5 percent of additive is needed but this may change if presence of fines is high in the aggregate. Tensile strength ratio is the indicator that most of the transportation agencies adopt to analyze the stripping effect in AC mixtures. Previous research has shown a poor correlation between TSR and HWTD results (29). Hamburg wheel tracking device can closely identify the effect of anti-stripping agents but it may underestimate the performance of mixes containing soft binder at fixed water test temperatures. Hydrated lime became the only anti-stripping agent used by CDOT since it has given positive results at the time to prevent moisture damage in the HWTD test. Anyways, CDOT states that some other anti-stripping agents may work as well as hydrated lime or better with some type of aggregates. Properties measured by the HWTD test of the mixtures modified with anti-stripping agents did not always show improvement in comparison with mixtures with no anti-stripping agents (32).

2.4.6 HWTD Related to Field Performance

It is a fact that HWTD is a test that simulates the real behavior of a pavement in service under traffic loading. Visually, permanent deformation and moisture damage (stripping) are similar between samples tested in HWTD and pavements in use. Usually the way to analyze field performance is by visual pavement condition survey. Cracking joint deficiencies, surface defects and random distresses are the general modes to visually classify these distresses according the Strategic Highway Research Program (SHRP) (33). After 5 years of testing and visually observing the pavements behavior, Yildirim and Stokoe (29) observed the relationship between HWTD and field performance. Visual pavement rating (VPR) was the method used to evaluate the different asphalt pavements. Low, moderate and high are the scales used to evaluate the distress in the specified pavement. Transverse cracking, fatigue cracking, longitudinal cracking, reflection cracking at joints, patching and potholes were analyzed. International roughness index may be also related to field performance and HWTD. The use of field cores was conducted for correlation purposes since it was found that HWTD is very sensitive to AV contents. Finally, rutting data was collected from field during some years and was compared with some field cores tested in the HWTD. It was noted that rutting was minor in field compared to what was observed in the laboratory. Other research was performed by comparing HWTD results and field performance. Correlation between test results and field performance observation was not satisfactory. It was found that some sections that performed well in the field showed good performance in the HWTD test, but a few section that performed poorly in the field also performed well in the HWTD test (34). It can be seen that HWTD test overestimate the performance of asphalt mixtures in service.

2.4.7 Gradation and Air Voids Effect

HWTD results are affected by different mixture design properties and test inputs as mentioned. Throughout the past of year's research to understand coarse and finer gradation to understand rutting and stripping distresses was performed. Kandhal and Cooley (35) defined gradations below and above the restriction zone to define finer and coarser mixtures. Mixtures tested in three different rutting susceptibility tests showed no significant difference between gradations. Gokhale et al. (36) used the accelerated pavement testing and asphalt pavement analyzer to evaluate coarse and fine superpave mixtures. Same findings as Khandal and Colley were observed. Golalipour et al. (37) defined three variations in mixtures gradation. Better rutting results were observed in upper limit variations (coarser gradation). In addition, a variation in testing results was observed when AV contents changed. Manal and Attia (38) tested three different types of aggregates using the wheel tracker test. Results shown improvement when coarse gradation was used in the AC mixture. Differently, Habbeb et al. (39) found less rutting when finer gradation mixtures were tested in the wheel tracker test. Kanitpong et al. (40) found that finer and coarser mixtures permanent deformation performance is related to the type of aggregate. In addition, finer mixtures appear to have greater stripping resistance. Studies showed mixtures with lower AV performed better. Permanent deformation and other distresses were sensitive to AV contents. Tarefder and Zamman (41) observed that AV contents and gradation are important rutting factors in AC mixtures using the asphalt pavement analyzer. Results showed an improvement in rutting resistance for lower AV contents and coarser gradations. Aschenbrener and Curier (23) tested 4 types of mixtures at different AV contents using the HWTD. Based on the results, a recommendation of 5 to 7 percent AV contents range was defined. Kassem et al. (42) stated that AV contents are less sensitive to HWTD results.

2.4.8 Warm Mix Asphalt Agents Effect

In the past years, the effort of industries to reduce the emission of carbon dioxide and other greenhouses was conducted by different research. WMA is being an alternative to HMA in order to reduce environmental effects and increase the benefits in terms of production, workability and economics. WMA can be classified by degree of temperature reduction or by technologies used to reduce temperature. Mostly, the technologies used to reduce temperature are foaming techniques, organic or wax additives and chemical additives. Variation of temperatures in the production of WMA has a wide range. From temperatures 10 °C to 20 °C below HMA to even temperatures close to boiling water.

Research using HWTD was conducted to understand the effect of agents in WMA deformation. Influence of curing time at the time of using WMA agents was found. Short term aging (2 hours) is less critical to HMA mixtures compared to WMA using HWTD test and Evotherm showed better results in terms of cycles to failure when the curing time was increased from 2 to 4 hours (43). Perkins (44) found the use of anti-stripping agents improved WMA mixtures in terms of rutting distresses. Liva and MacBroom (45) tested WMA mixtures with different agents. AC with a PG 64-28 binder was tested using different Synthetic Zeolite Products (SZP), Evotherm agents and Sasobit. SZP did not show improvement for rutting distresses and stripping was observed. Otherwise, Evotherm 3G showed improvement in rutting and stripping was not observed. Finally, improvement was observed for Evotherm DAT modified and Sasobit for rutting and stripping behavior. Hurley and Prowell (46) have tested WMA mixtures with two different binder grades and type of aggregates. PG 64-22 and PG 76-22 binder grades were used with limestone and granite as type of aggregates. Four mixes were tested with and without Evotherm WMA agent. Results showed an improvement in the rutting rate (mm/hr.) when WMA

mixtures were in presence of Evotherm agent. In addition, their study observed that Evotherm improves the compactability in the SGC and vibratory compactor.

Colorado department of transportation tested WMA mixtures with a PG58-28 binder grade and three WMA technologies (Advera, Evotherm and Sasobit). Results showed no improvement between WMA technologies and HMA control mixtures (47). Jones et al. (48) conducted a comparison between WMA mixtures with Cecabase, Gencor and Evotherm DAT agents and a control HMA mixture. AV range was between 6.3 and 7.0 %. Results showed that HMA mixture and WMA mixtures with Evotherm DAT and Cecabase RT behaved similar with a maximum rutting depth of 10 mm. Otherwise, WMA mixture with Gencor exceeded the 12.5 mm maximum impression point set by most of transportation state agencies. Table 1 shows a summary of the previously mentioned HWTD results for WMA mixtures in presence of different Evotherm agents and Cecabase.

Table 2.2 Summary of AC HWTD Results in Presences of WMA Agents

Ref.	Observation	HWTD Results									
		HMA Control		Evotherm		Evotherm DAT		Evotherm 3G		Cecabase	
		Rut Depth (mm)	No. of Cycles	Rut Depth (mm)	No. of Cycles	Rut Depth (mm)	No. of Cycles	Rut Depth (mm)	No. of Cycles	Rut Depth (mm)	No. of Cycles
(43)	2 Hour Curing Time	Failed	9,500	Failed	6,000	N/A	N/A	N/A	N/A	N/A	N/A
	4 hour Curing Time	Failed	11,500	Failed	16,000	N/A	N/A	N/A	N/A	N/A	N/A

(45)	PG 64-28	5.1	20,000	N/A	N/A	7.6	20,000	5.6	20,000	N/A	N/A
(46)	PG64-22 Granite	5.9	10,000	5.8	10,000	N/A	N/A	N/A	N/A	N/A	N/A
	PG76-22 Granite	2.3	10,000	1.9	10,000	N/A	N/A	N/A	N/A	N/A	N/A
	PG64-22 Limestone	13.8	10,000	10.2	10,000	N/A	N/A	N/A	N/A	N/A	N/A
	PG76-22 Limestone	4.9	10,000	4.3	10,000	N/A	N/A	N/A	N/A	N/A	N/A
(47)	PG58-28	10	9,650	N/A	N/A	13.5	7,750	N/A	N/A	N/A	N/A
(48)	PG64-16	10	20,000	N/A	N/A	10.3	20,000	N/A	N/A	10.4	20,000
(49)	PG64-22 J1 Type	5.4	20,000	N/A	N/A	N/A	N/A	3.4	20,000	N/A	N/A
	PG64-22 M1 Type	5.4	20,000	N/A	N/A	N/A	N/A	3.5	20,000	N/A	N/A

The above discussion describes the effect of different factors on WMA mixtures with different agents tested in HWTD. However, no study reports any modeling which can be used to determine the rutting behavior of AC under HWTD test related to WMA agents.

2.4.9 Weibull Function

The Weibull distribution is widely used in reliability engineering and elsewhere due to its versatility and relative simplicity. Weibull function is given by Eq. (1):

$$Fr(N) = \frac{\beta}{\eta} \left[\frac{N-\gamma}{\eta} \right]^{\beta-1} \quad (1)$$

where

$Fr(N)$ = deformation rate at different cycles

β = shape parameter

η = scale parameter

γ = location parameter

Shape Parameter (β) shows the effect of how deformation rate increases or decreases in the function. Weibull function with $\beta < 1$ has a deformation rate that decreases with time, also known as early-life failures. Weibull function with β close to or equal to 1 has a constant deformation rate. After post-compaction phase, rutting have a tendency to creep with a constant deformation rate until stripping phase is reached. For this study, it was found that shape parameters are close to 1. Otherwise, Weibull function with $\beta > 1$ has a deformation rate that increases with time. Figure 2 shows the commonly named “bathtub curve” for this parameter. Scale Parameter (η) is closely related to the effect of stretching out the function while β is constant. Regularly, Location Parameter (γ) is not used and the parameter can be set as zero. Since, N must be greater than γ and, the starting point for N is zero, γ was not used for this study.

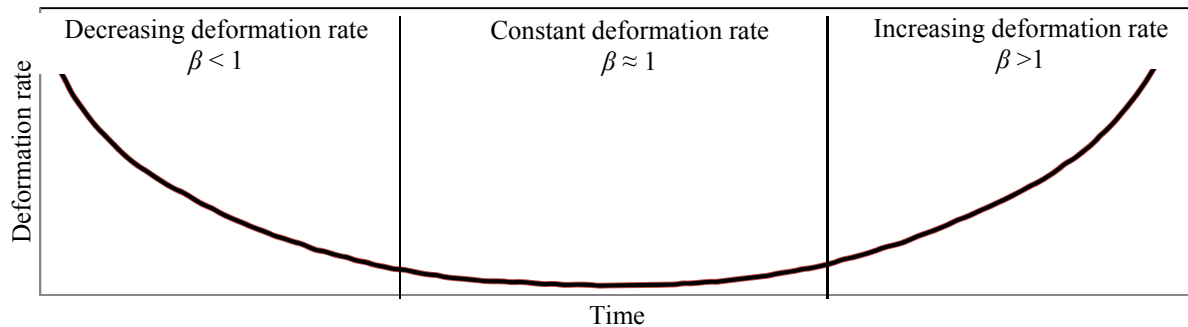

Figure 2.8 Shape parameter (β) curve

In the past years, the application of Weibull distribution to predict pavement performance was studied. Coleri et al. (50) demonstrated the application of the integrated Weibull approach to observe in-situ rutting performance of AC. Results showed that integrated Weibull approach was successful and it is a reliability method to predict in-situ rutting. Peng et al. (51) showed the

application of Weibull distribution in pavement performance. First, the application of the distribution was performed to simulate the pavement performance. Secondly, a prediction model was constructed to observe pavement performance. Results showed a good performance of the distribution model. Yin et al. (52) used a Novel method for rutting evaluation using HWTD. Three new parameters to evaluate rutting were proposed and good correlation was found when rutting was the only distress in the test.

Chapter 3 MATERIALS & EXPERIMENTAL METHODOLOGY

3.1 GENERAL

This section highlights the material properties and experimental methodology associated with this study. Materials collection and classification with respect to type of mixture, gradation, binder performance grade asphalt and type of aggregate are addressed. Brief description of sample preparation, experimental setup and deformation measurement for Hamburg wheel testing device under different water temperatures are included.

3.2 MATERIAL SOURCE AND CLASSIFICATION

Twenty SP III HMA/WMA mixtures were used in this study. Fourteen WMA mixtures and six HMA mixtures were collected. Four different binders PG (64-28, 70-22, 76-22, and 76-28) were defined in this study. One of the mixtures was in presence of a modified polymer. Type of aggregates such as sand and gravel, river deposits, limestone, shale, dacite, quartzite and basalt were studied.

3.2.1 Material Collection

HMA/WMA mixtures were collected in warm bulk condition from different districts in the state of New Mexico. AASHTO T 168-11 (3) method was used to collect the asphalt. Shoveling was done to facilitate sampling and transportation of mixes in warm state to the laboratory. Paper bags were used as sample containers and filled with 30 to 40 pounds of asphalt approximately per bag. After collection mixes were storage properly to avoid aging. Sampling is an important step for this research and precautions were taken to obtain a truly representative sample. The following table summarizes the AC mixtures collected. Figure 3.1 depicts the procedure for AC mixtures collected.

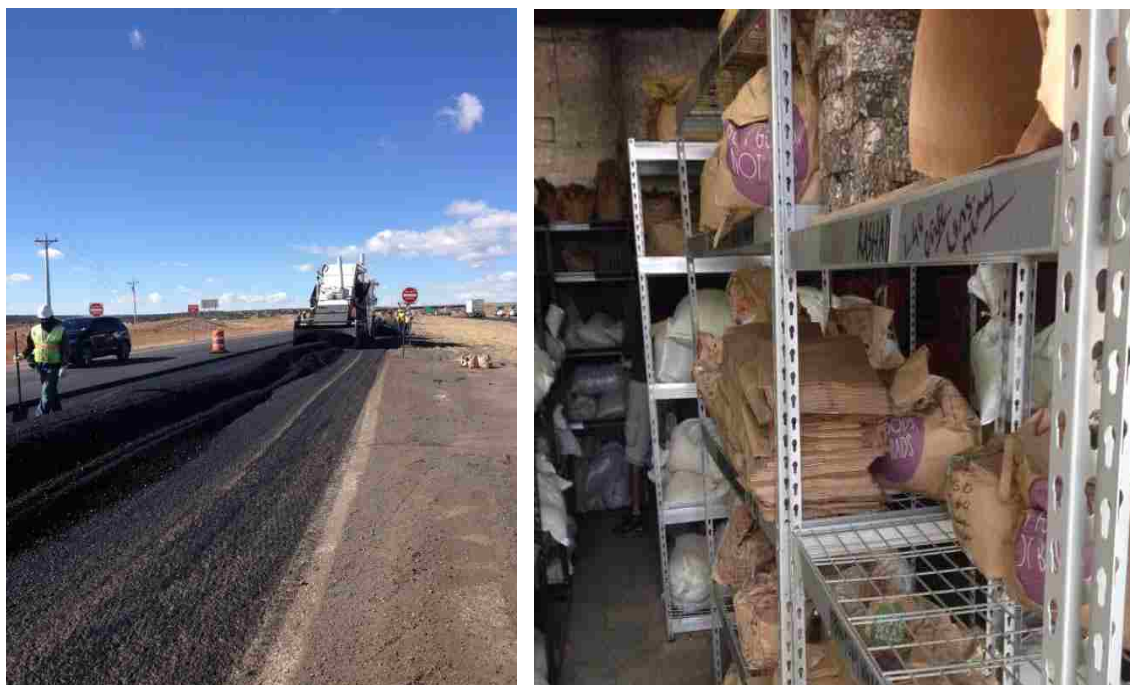

Figure 3.1 Collection and storage of material

3.2.2 HMA/WMA Mixtures Collection

HMA/WMA mixtures collected in five districts differ in type of mixture, type of aggregate and binder grade. The pavement section of mixtures 8, 9, 10, 11 and 12 was one of the Specific Pavement Study Section-10 (SPS-10) of the nationwide Long-Term Pavement Performance (LTPP) monitoring program. Five WMA/HMA mixtures were collected with same mixture designs only differing in the type of mixture, WMA agent and modified polymer. Table 3.1 describes the properties for each AC mixture collected.

Table 3.1 Materials Collected

No. Mixture	Mix Code	Type	Aggregate	PG
1	D1A	WMA	Sand and Gravel	76-22
2	D2A	WMA	Limestone	76-22
3	US54N	WMA	River Deposits	70-22
4	D4A1	HMA	Basalt	64-28
5	D4A2	WMA	River Deposits	76-22
6	D4A3	HMA	Shale	64-28
7	D6A	WMA	Dacite	76-28
8	SPS10-1	HMA	Sand and Gravel	76-22
9	SPS10-2	WMA	Sand and Gravel	76-22
10	SPS10-3	WMA	Sand and Gravel	76-22
11	SPS10-4	WMA	Sand and Gravel	76-22
12	SPS10-5	WMA	Sand and Gravel	76-22*
13	D4A4	WMA	Sand and Gravel	76-22
14	Sierra	WMA	Sand and Gravel	76-22
15	Belen	HMA	Basalt	76-22
16	FSG	WMA	Sand and Gravel	64-28
17	Rio Bravo	WMA	Basalt	76-22
18	NM333	HMA	Quartzite	70-22
19	Sandoval	WMA	Sand and Gravel	76-22
20	US54S	HMA	River Deposits	70-22

(*) In presence of a modified polymer

As mentioned, AC mixtures 8 to 12 only differ in the WMA agent used if the case. For gradation purposes only 16 mixtures were analyzed since SPS-10 mixtures have the same gradation and mixtures properties. Gradations with higher area above the maximum density line than below were considered as finer mixtures. Differently, mixtures were considered coarser as shown in Figure 3.2. Asphalt concrete mixtures were differenced in eleven coarser SP III and nine finer SP III mixtures.

Table 3.2 Mixtures Gradation

Mixture	Area Above	Area Below	Area Ratio	Finer - Coarser
1	1.26563	1.50977	0.83829325	Coarse
2	3.24219	0.53444	6.06651822	Finer
3	1.37305	2.80273	0.48989735	Coarse
4	2.76367	0.87811	3.14729362	Finer
5	1.3125	3.51168	0.37375273	Coarse
6	2.84766	1.05042	2.71097275	Finer
7	3.23633	0.54297	5.96042139	Finer
8				
9				
10	0.80664	2.34281	0.34430449	Coarse
11				
12				
13	0.86523	3.34055	0.25900825	Coarse
14	5.79688	0.5081	11.4089352	Finer
15	4.49219	1.04906	4.2821097	Finer
16	0.79688	5.28125	0.15088852	Coarse
17	5.50391	0.89329	6.16139216	Finer
18	3.83008	0.43359	8.83341405	Finer
19	2.89648	3.14258	0.92168855	Coarse
20	2.35547	1.15435	2.04051631	Finer

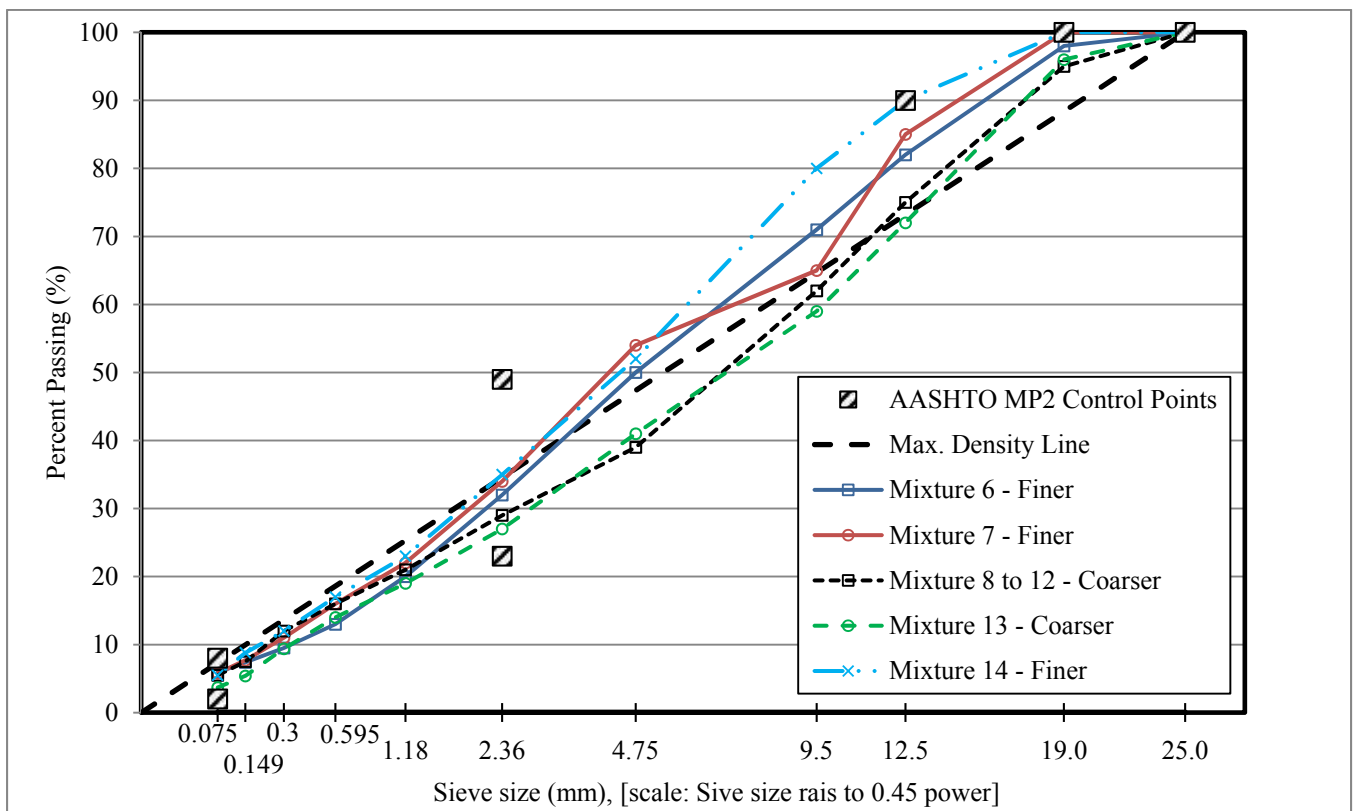
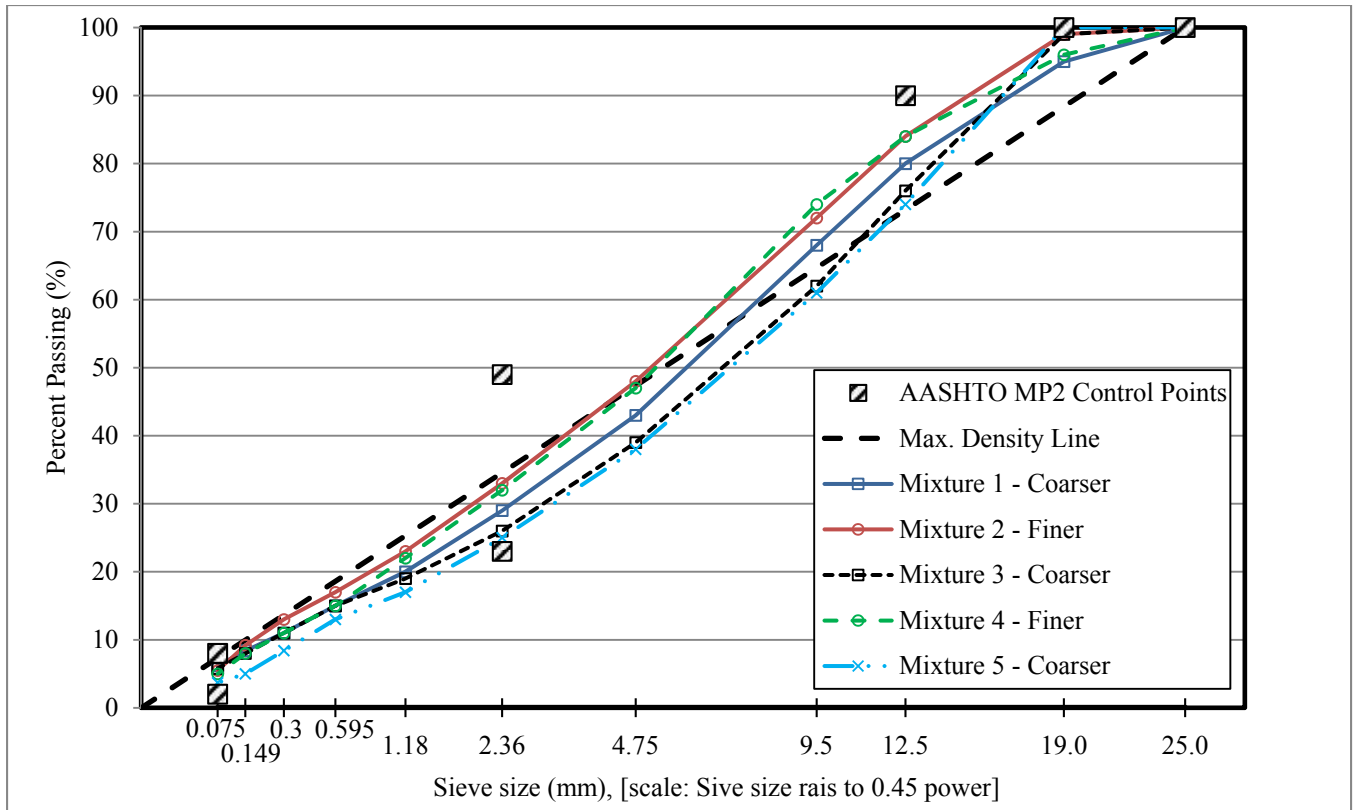

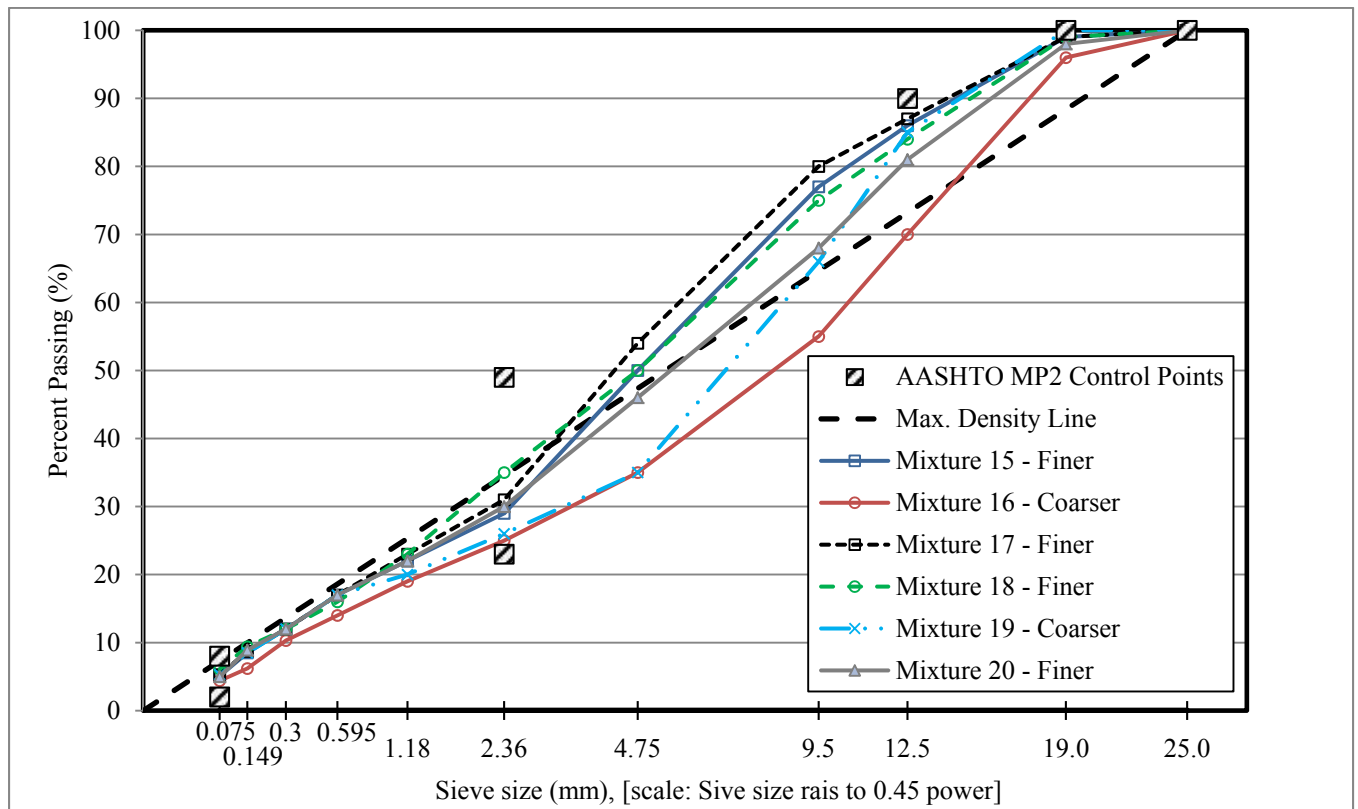

Figure 3.2 Mixtures gradation according the maximum density line

3.3 SPECIMEN PREPARATION AND COMPACTION

3.3.1 Sample Size

In general, there are three standard ways to perform HWTD test: Cubical, cylindrical and field core samples. For this research only laboratory compacted cylindrical samples were used and prepared. To perform HWTD test a 60 mm. (2.4 in.) height cylindrical sample with 150mm. (6 in.) diameter is defined according AASHTO T 324. Since sample will be fixed in a HDP sheet with 60 mm. height, a modification in the laboratory sample was necessary. Samples were increased in height by 2 ± 1 mm. to avoid vibration in the LVDT since the steel wheel may have contact with the HDP sheet.

3.3.2 Theoretical Maximum Specific Gravity (G_{mm})

Theoretical Maximum Specific Gravity (G_{mm}) is given for AC mixtures in the mixture design sheet provided by NMDOT. Since HWTD test is sensible due air void content of the samples and the theoretical maximum specific gravity is related to this parameter, G_{mm} was performed to assure the value of this parameter and get accurate air void results. AASHTO T 209-11 was used as standard method. Loose sample of plant produced HMA/WMA mixtures was weighted in dry condition and then divided in three equal parts to average the different results for this parameter. AC mixtures should be loose and broken up so that the fine aggregate is separated into particles. A pycnometer was used as container enclosed to a vacuum pressure gauge to absorb the voids placed in the sample. To release the most voids in the sample a vibro-deairator was attached to the pycnometer. Figure 3.3 depicts the photograph of a typical configuration used in the laboratory.



Figure 3.3 Maximum theoretical specific gravity procedure

There are two methods to obtain the theoretical maximum specific gravity in the AASHTO T 209-11. Weighing in air or water is the difference cited in the standard method. For this analysis, air weighing was used under the following equation.

$$G_{mm} = \frac{A}{A+D-E} \quad (2)$$

Where:

- G_{mm} = theoretical maximum specific gravity
- A = sample mass in air (g)
- D = mass of flask filled with water (g)
- E = mass of flask and sample filled with water (g)

3.3.3 Sample Compaction

AASHTO T 312-11 requires a fixed sample amount to reach the target air void content in compacted samples. Target AV contests for all samples was fixed at five to seven percent since six percent air void content is the design parameter in New Mexico. A tolerance of one percent was applied for this research since air void content results in laboratory are very sensitive. Obtaining the correct air void content in a compacted sample is related to the amount of sample to be compacted. This amount is related to the target air void content, volume of the sample and leftovers. Density is related to the bulk specific gravity with the following equation:

$$G_{mb} = \gamma = \frac{W}{V} \quad (3)$$

Where:

- G_{mb} = bulk specific gravity
- γ = density (g/cc)
- W = mass of sample (g)
- V = volume of sample (cc)

The concept of air void content is related to the theoretical maximum specific gravity and the bulk specific gravity. The following equation obtained from literature explains the relationship by definition between this two specific gravities and air void content:

$$AV = 1 - \frac{G_{mb}}{G_{mm}} \quad (4)$$

Where:

$$G_{mb} = (1 - AV) * G_{mm} \quad (5)$$

Where:

- AV = air void percentage
- G_{mb} = bulk specific gravity
- G_{mm} = theoretical maximum specific gravity

Replacing equation 5 in equation 3 the following equation is obtained:

$$W = V * (1 - AV) * G_{mm} \quad (6)$$

1% of W equivalent in grams of sample is added to this equation since the manipulation of loose sample may cause some differences in the right amount of sample. The volume of the sample was calculated for the previously defined sample size, a 150 mm. diameter cylinder with 64 mm.

height was set. The following equation was used to calculate the right amount of sample in terms of air void content, the specified volume of the sample and the theoretical maximum specific gravity of mixture to be compacted.

$$W_{final} = W \pm 1\% \text{ of } W \quad (7)$$

Once weight of sample is defined by previous equation mixture is ready to be compacted in the Superpave Gyrotory Compactor (SGC). Equipment may compact samples in two ways, by height definition and number of gyrations. Since height is fixed at 62 mm, the first method was used. Once height is defined for compaction a second parameter must be configured. Aschenbrener (1) states that HWTD test results are very sensitive to temperature compaction. VanFrank and Romero (53) showed that losing temperature in samples at the time to be compacted will have an important variation in HWTD test results. For this research, compaction temperature was assumed as indicated in the mixture design sheet. Molds and utensils for compaction were also placed in oven at same temperature to maintain temperature in the sample all time. Mixes were placed in oven between two and three hours for aging. The longer the time of the mix in the oven the more aging will have. Previous research showed that aged the mix the stiffer it becomes. After compaction, samples were marked and storage to prevent extra aging.



Figure 3.4 Sample compaction

3.3.4 Air Voids Contents

As stated in equation two, air void content is in function of the theoretical maximum specific gravity and the bulk specific gravity. To obtain the precise air void content of each compacted sample, the bulk specific gravity must be defined. AASHTO T 166-11 was used as standard method to find G_{mb} . Saturated surface dry (SSD) and CoreLok are the most important procedure

to define bulk specific gravity with water displacement. Surface Saturated Dry (SSD) method was used for all compacted samples in order to find the air void contents. The following equation explicates the procedure to find the bulk specific gravity:

$$G_{mb} = \frac{A}{B-C} \quad (8)$$

Where:

- G_{mb} = bulk specific gravity
- A = mass of sample in air (g)
- B = mass of SSD sample in air (g)
- C = mass of sample in water (g)

A pressurized chamber and a vibro-deairator were implemented for the SSD process to obtain higher accuracy in air void results. The temperature of the water was also recorded since density of water varies at different temperatures. Sample was placed in the pressurized chamber with water, a pressure gauge was attached at the top of the chamber to absorb voids and finally while voids were being absorbed a vibro-deairator was attached to the chamber to vibrate and release more voids in the sample. Samples were exposed under these conditions for 15 minutes. In this manner most of the voids in sample will be filled with water. Water quickly drains out of the sample when is removed from the water chamber, especially for high air void content specimens. This issue may result in a low SSD weight leading to have an erroneous bulk specific gravity. To avoid this issue in this research; scale, chamber and weight water bath were closed enough to avoid water loses in the measurements. The following figure depicts the procedure to obtain bulk specific gravity.



Figure 3.5 Bulk specific gravity procedure

Once bulk specific gravity for each specimen is defined AV contents may be calculated as shown in Equation 9.

$$\text{Air Voids (percent)} = \left(\frac{G_{mm} - G_{mb}}{G_{mm}} \right) * 100 \quad (9)$$

Where:

- G_{mb} = bulk specific gravity
- G_{mm} = maximum theoretical specific gravity

3.3.5 Final Details

Once samples were compacted and air void content was measured a cutting step was performed in the cylindrical samples. As shown in Figure 2.6, the configuration for HWTD requires a small cut in the edge of two samples to induct a plane surface contact between them and also to fit in the HWTD polyethylene mold. Obtain flat surfaces in this step is very important since irregular cuts may lead to excessive vibration in the LVDTs. A cut of 7 to 10 mm with a masonry cutting saw in order to get the right geometry of the sample was conducted. Figure 3.6 depicts the final product to be tested.



Figure 3.6 Final product

3.4 EXPERIMENTAL PROGRAM

HWTD tests were conducted on each HMA/WMA mixture. A variation of temperature in the wet test was experimented. Once samples were placed in molds and no gaps were present mounting trays were filled with the molds in an empty water bath. Test configuration was activated via software using a computer control. Test configurations were as follows:

- Testing Temperature: 40°C, 50°C and 60°C
- Load: 158 lb. (707 N)
- Number of passes per minute (RPM): 52
- Maximum number of passes: 20,000
- Maximum rutting depth: 20 mm
- Rut-depth measurement: every 20 passes until 8000 passes, every 40 passes until 16000 passes and every 80 until the end of the test

Water was turned on after samples were ready to test. Cold and hot water was used to reach the designated test temperature for each of the tests. Once the temperature was reached samples were 30 minutes in water bath to get saturated and conditioned. After conditioning, wheels were lowered so they rested on the samples and the test started. Test stopped either the maximum rutting depth was reached or the maximum number of wheel passes was reached, whichever occurs first. Post compaction, creep slope, stripping slope and the stripping inflection point were obtained from the graphic of rutting depth versus number of wheel passes.

3.4.1 Deformation Measurement Techniques

Permanent deformation (rutting) is measured with two LVDTs placed in the far end of each wheel. These LVDTs records the rutting depth with a 0.01 mm precision using computer software named wheel tracker. The University of New Mexico HWTD is able to measure the

rutting depth along the two samples in eleven points across; Figure 3.7 depicts the configuration for the eleven points.

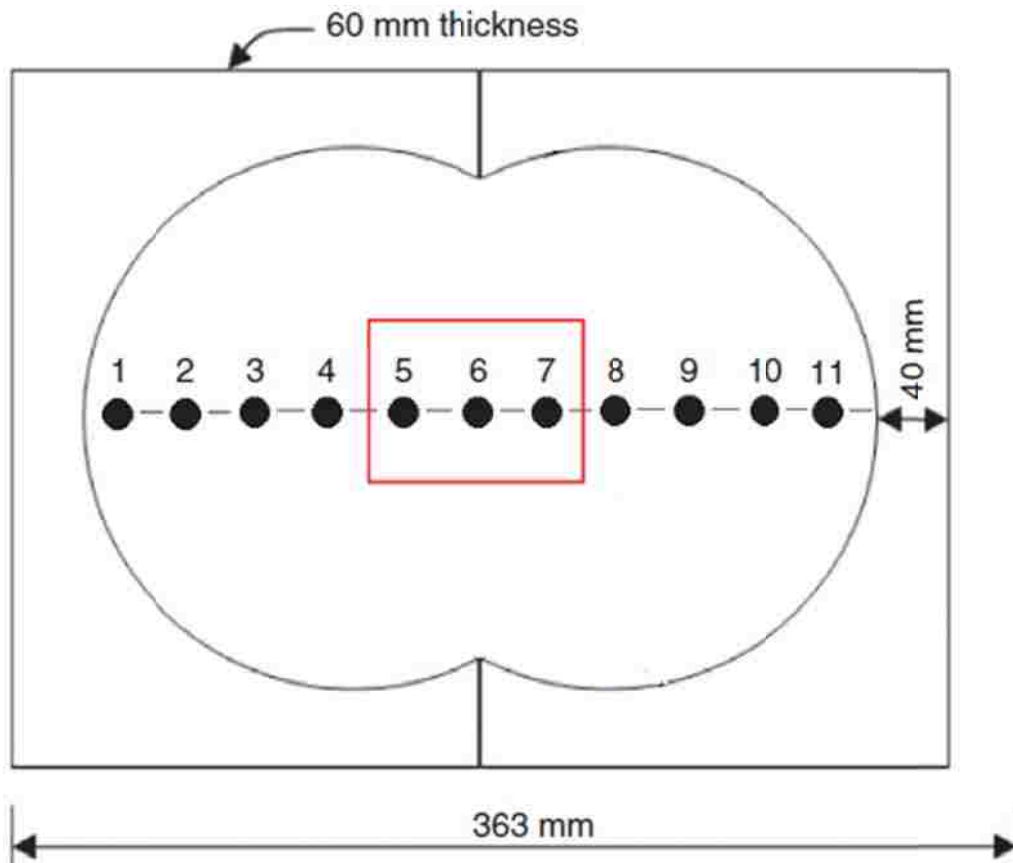

Figure 3.7 Deformation measurement LVDT's configuration

Since LVDTs records a rutting depth data for each of the eleven points in a wheel pass an average criterion must be assumed. The software uses three criteria to average the deformation for each wheel pass. Mid, Full and Fail criteria differ from the method of average the rutting depth across the eleven points. Mid criterion assume the rutting depth for each wheel pass averaging points 5, 6 and 7 from the wheel path. This criterion is commonly used but some researchers defined as a not valid criterion since point 6 depends totally on the contact between the two samples and is in the interface. Full criterion adopts a rutting depth without averaging three points; it uses the critical point along the wheel path. Full criterion define rutting depth for

each wheel pass as the average of three points; the previous and the continuous points from the critical point, it also includes the critical point in the average process. Points 1 and 11 are commonly discarded since rutting depths do not represent the tendency of the wheel path rutting depth. For this research the average of results from the fifth to the ninth point was used in the analysis following the recommendation of Schram et al. (54).

3.5 TEST MATRIX

This study tested twelve HMA/WMA mixtures in the HWTD at three different water bath temperatures. For each of the tests four compacted samples were necessary at 6 ± 1 air void percentage. Obtaining the right final product depends totally in all the procedure mentioned above. Since this process is long, errors may occur due handling. Table 3.2 illustrates the overall HWTD test matrix for this study. For this study, 184 samples were compacted and 92 tests were performed.

Table 3.3 HWTB Test Matrix

No. Mixture	Mix Code	Type	Aggregate	PG	Gradation	Temperature °C	No. of Tests
1	D1A	WMA	Sand and Gravel	76-22	Coarser	40	2
						50	4
						60	2
2	D2A	WMA	Limestone	76-22	Finer	40	2
						50	4
						60	2
3	US54N	WMA	River Deposits	70-22	Coarser	40	2
						50	6
						60	2
4	D4A1	HMA	Basalt	64-28	Finer	40	2
						50	4
						60	2
5	D4A2	WMA	River Deposits	76-22	Coarser	40	2
						50	3
						60	2
6	D4A3	HMA	Shale	64-28	Finer	40	2
						50	4
						60	2
7	D6A	WMA	Dacite	76-28	Finer	40	1
						50	4
						60	2
8	SPS10-1	HMA	Sand and Gravel	76-22	Coarser	50	2
9	SPS10-2	WMA	Sand and Gravel	76-22	Coarser	50	2
10	SPS10-3	WMA	Sand and Gravel	76-22	Coarser	50	2
11	SPS10-4	WMA	Sand and Gravel	76-22	Coarser	50	2
12	SPS10-5	WMA	Sand and Gravel	76-22*	Coarser	50	2
13	D4A4	WMA	Sand and Gravel	76-22	Coarser	50	4
14	Sierra	WMA	Sand and Gravel	76-22	Finer	50	4
15	Belen	HMA	Basalt	76-22	Finer	50	3
16	FSG	WMA	Sand and Gravel	64-28	Coarser	50	3
17	Rio Bravo	WMA	Basalt	76-22	Finer	50	3
18	NM333	HMA	Quartzite	70-22	Finer	50	3
19	Sandoval	WMA	Sand and Gravel	76-22	Coarser	50	3
20	US54S	HMA	River Deposits	70-22	Finer	50	3

Chapter 4 PARAMETER EFFECT IN HAMBURG WHEEL TRACKING DEVICE

4.1 GENERAL

This chapter is dedicated to present the results and discussions of the Hamburg wheel tracking device test results for different AC mixtures.

Specific objectives of this chapter are:

- Evaluate the effect of type of mixture, gradation, binder grade and type of aggregate due to HWTD temperature test.
- Asses the HWTD main results for the studied parameters.
- Evaluate the effect of AV contents for the studied parameters

Hamburg wheel tracking device results for HMA/WMA mixtures tested are shown in Table 4.1.

The following table summarizes the most reliable results obtained from HWTD software. Results were processed in order to obtain three key parameters (post compaction, creep and stripping slope). From literature, it was observed that these parameters in HWTD are key factor to analyze the behavior of the AC mixtures when HWTD test was performed. In addition, rutting depths were also summarized in different number of wheel passes along with the maximum rutting depth and the number of passes at the end of each test. SIP was defined with the corresponding rutting depth if mixture showed signs of stripping. Finally, the AV content for each path tested was defined due the effect of this parameter in AC mixtures under HWTD test.

Table 4.1 HWTD Results

Mixture	Temp.	AV	Max Rut Depth	Max Passes	N pc	Slope 1	Slope 2	Slope 3	SIP	SIP Rut	Rut 1000	Rut 5000	Rut 10000	Rut 15000
1	50	5.88	2.44	20,000	1,000	1,099	13,211	N/A	N/A	N/A	0.91	1.44	1.82	2.44
		6.57	3.35	20,000	1,000	701	12,257	N/A	N/A	N/A	1.43	2.32	2.86	3.14
	50	5.59	2.11	20,000	1,000	1,124	20,764	N/A	N/A	N/A	0.89	1.51	1.71	1.99
		6.64	2.33	20,000	1,000	1,085	15,648	N/A	N/A	N/A	0.92	1.43	1.74	2.07
	40	5.48	1.23	20,000	1,000	1,381	48,012	N/A	N/A	N/A	0.72	0.97	1.07	1.18
		6.82	1.53	20,000	1,000	1,287	37,567	N/A	N/A	N/A	0.78	1.06	1.19	1.33
	60	5.09	3.60	20,000	1,000	884	8,148	N/A	N/A	N/A	1.13	1.90	2.66	3.13
		5.90	3.17	20,000	1,000	767	11,047	N/A	N/A	N/A	1.31	2.01	2.51	2.92
2	40	6.51	1.41	20,000	1,000	1,088	73,451	N/A	N/A	N/A	0.92	1.26	1.33	1.39
		6.85	1.35	20,000	1,000	1,540	33,477	N/A	N/A	N/A	0.65	1.02	1.22	1.32
	50	5.60	1.85	20,000	1,000	972	27,882	N/A	N/A	N/A	1.03	1.34	1.59	1.70
		6.05	2.21	20,000	1,000	823	18,964	N/A	N/A	N/A	1.22	1.58	1.86	2.11
	50	5.33	1.56	20,000	1,000	1,371	34,495	N/A	N/A	N/A	0.73	1.12	1.23	1.28
		5.47	1.61	20,000	1,000	1,545	23,584	N/A	N/A	N/A	0.65	0.98	1.29	1.51
	60	5.09	8.09	20,000	1,000	782	5,709	1,501	13,850	3.71	1.28	2.22	3.10	4.76
		5.25	6.73	20,000	1,000	749	6,951	2,560	10,180	3.10	1.34	2.32	3.04	4.78

Mixture	Temp.	AV	Max Rut Depth	Max Passes	N pc	Slope 1	Slope 2	Slope 3	SIP	SIP Rut	Rut 1000	Rut 5000	Rut 10000	Rut 15000	
3	50	5.62	3.16	20,000	1,000	836	15,901	N/A	N/A	N/A	1.20	1.97	2.53	2.81	
		6.44	2.70	20,000	1,000	878	20,046	N/A	N/A	N/A	0.98	1.84	2.20	2.45	
	50	5.96	2.72	20,000	1,000	1,075	15,073	N/A	N/A	N/A	0.93	1.63	2.05	2.72	
		6.42	2.41	20,000	1,000	818	37,711	N/A	N/A	N/A	1.22	1.78	2.14	2.41	
	40	6.08	1.67	20,000	1,000	1,354	28,365	N/A	N/A	N/A	0.74	1.04	1.32	1.55	
		6.84	2.56	20,000	1,000	980	27,648	N/A	N/A	N/A	1.02	1.71	2.20	2.42	
	60	6.29	4.02	20,000	1,000	554	10,043	N/A	N/A	N/A	1.81	2.63	3.16	3.52	
		6.26	3.78	20,000	1,000	679	11,445	N/A	N/A	N/A	1.47	2.28	2.87	3.35	
	50	6.31	3.23	20,000	1,000	861	11,010	N/A	N/A	N/A	1.16	1.86	2.42	2.81	
		7.00	3.28	20,000	1,000	967	9,164	N/A	N/A	N/A	1.03	1.64	2.12	2.60	
	4	50	5.03	2.36	20,000	1,000	830	24,065	N/A	N/A	N/A	1.21	1.83	2.08	2.24
			5.75	2.26	20,000	1,000	677	38,447	N/A	N/A	N/A	1.48	1.90	2.01	2.16
		60	5.72	3.59	20,000	1,000	650	13,922	N/A	N/A	N/A	1.54	2.43	2.90	3.15
			6.90	3.94	20,000	1,000	625	11,816	N/A	N/A	N/A	1.60	2.76	3.60	3.94
50		6.61	2.57	20,000	1,000	751	21,397	N/A	N/A	N/A	1.33	1.93	2.22	2.39	
		6.92	2.86	20,000	1,000	638	22,523	N/A	N/A	N/A	1.57	2.27	2.43	2.72	

Mixture	Temp.	AV	Max Rut Depth	Max Passes	N pc	Slope 1	Slope 2	Slope 3	SIP	SIP Rut	Rut 1000	Rut 5000	Rut 10000	Rut 15000
	40	7.37	2.04	20,000	1,000	762	52,168	N/A	N/A	N/A	1.31	1.75	1.99	2.09
		8.43	1.80	20,000	1,000	942	72,728	N/A	N/A	N/A	1.06	1.60	1.66	1.68
5	50	5.02	1.94	20,000	1,000	1,369	19,503	N/A	N/A	N/A	0.73	1.17	1.51	1.75
	50	5.36	2.10	20,000	1,000	1,199	15,574	N/A	N/A	N/A	0.83	1.13	1.50	1.81
		5.54	2.86	20,000	1,000	955	12,760	N/A	N/A	N/A	1.05	1.68	2.02	2.46
	40	5.01	1.24	20,000	1,000	1,137	169,698	N/A	N/A	N/A	0.88	1.05	1.18	1.21
		5.66	1.14	20,000	1,000	1,380	89,477	N/A	N/A	N/A	0.72	0.82	1.03	1.10
	60	5.37	17.28	9,916	500	367	1,210	404	2,500	5.00	1.84	6.19	N/A	N/A
6.28		17.77	6,800	500	297	649	134	4,900	4.66	2.43	12.37	N/A	N/A	
6	50	5.90	15.48	14,812	500	276	1,338	557	10,900	8.21	2.40	4.07	7.81	N/A
		6.97	16.75	13,818	500	309	1,195	329	11,290	9.10	2.11	3.97	8.16	N/A
	60	5.09	19.00	5,600	500	249	599	255	1,980	4.00	2.69	16.66	N/A	N/A
		5.26	16.72	6,664	500	243	764	306	3,290	5.25	2.61	11.05	N/A	N/A
	50	5.02	15.78	9,872	1,000	328	1,100	443	6,400	7.71	3.05	6.68	N/A	N/A
		5.13	17.73	16,766	1,000	509	2,269	719	7,700	4.85	1.97	3.73	8.02	15.27
	40	5.21	4.10	20,000	1,000	951	6,611	N/A	N/A	N/A	1.05	1.83	2.40	3.19

Mixture	Temp.	AV	Max Rut Depth	Max Passes	N pc	Slope 1	Slope 2	Slope 3	SIP	SIP Rut	Rut 1000	Rut 5000	Rut 10000	Rut 15000
		6.37	3.14	20,000	1,000	1,022	10,737	N/A	N/A	N/A	0.98	1.75	2.36	2.67
7	50	5.05	15.86	20,000	500	440	2,992	843	10,400	4.33	1.42	2.76	5.05	9.93
		6.98	16.55	15,314	500	376	1,946	636	8,300	5.10	1.73	3.78	8.10	16.55
	40	6.99	2.18	20,000	1,000	1,043	22,749	N/A	N/A	N/A	0.96	1.52	1.79	2.10
	50	5.92	17.82	12,994	500	452	2,184	584	4,310	2.95	1.43	4.12	13.56	N/A
		6.56	17.98	14,418	500	381	2,534	499	7,710	4.01	1.59	3.17	9.12	12.49
	60	5.52	19.13	3,942	500	243	522	133	2,080	5.00	3.02	N/A	N/A	N/A
		6.85	17.60	4,612	500	238	818	211	1,600	3.34	2.72	N/A	N/A	N/A
	8	50	5.67	3.54	20,000	1,000	702	13,766	N/A	N/A	N/A	1.42	2.30	2.80
6.03			5.98	20,000	1,000	651	4,091	N/A	N/A	N/A	1.54	2.42	3.53	4.66
9	50	6.16	4.30	20,000	1,000	640	9,215	N/A	N/A	N/A	1.56	2.69	3.22	3.81
		5.23	5.23	20,000	1,000	640	5,232	N/A	N/A	N/A	1.56	2.55	3.32	4.21
10	50	6.04	4.42	20,000	1,000	546	11,147	N/A	N/A	N/A	1.83	3.10	3.53	4.06
		5.94	4.91	20,000	1,000	475	7,571	N/A	N/A	N/A	2.11	3.15	3.59	4.25
11	50	6.88	3.46	20,000	1,000	763	13,283	N/A	N/A	N/A	1.31	2.18	2.70	3.06
		6.52	3.96	20,000	1,000	911	9,491	N/A	N/A	N/A	1.10	2.00	2.90	3.46

Mixture	Temp.	AV	Max Rut Depth	Max Passes	N pc	Slope 1	Slope 2	Slope 3	SIP	SIP Rut	Rut 1000	Rut 5000	Rut 10000	Rut 15000
12	50	6.54	2.23	20,000	1,000	1,229	18,501	N/A	N/A	N/A	0.81	1.30	1.69	1.92
		6.92	2.59	20,000	1,000	1,113	16,487	N/A	N/A	N/A	0.90	1.49	1.99	2.29
13	50	6.24	2.19	20,000	1,000	835	40,338	N/A	N/A	N/A	1.20	1.58	1.94	2.09
		6.22	4.62	20,000	1,000	366	18,570	N/A	N/A	N/A	2.73	3.43	4.08	4.52
	50	6.78	2.88	20,000	1,000	850	17,482	N/A	N/A	N/A	1.18	1.88	2.30	2.64
		6.94	4.15	20,000	1,000	744	7,312	N/A	N/A	N/A	1.34	2.08	2.79	2.59
14	50	5.03	1.89	20,000	1,000	1,184	21,905	N/A	N/A	N/A	0.84	1.20	1.39	1.77
		5.60	2.83	20,000	1,000	875	12,640	N/A	N/A	N/A	1.14	1.64	2.09	2.42
	50	5.34	2.74	20,000	1,000	970	13,193	N/A	N/A	N/A	1.03	1.61	1.94	2.26
		5.40	2.36	20,000	1,000	1,126	13,683	N/A	N/A	N/A	0.89	1.26	1.65	1.99
15	50	5.11	1.91	20,000	1,000	991	32,165	N/A	N/A	N/A	1.01	1.45	1.58	1.76
	50	5.57	2.43	20,000	1,000	888	20,420	N/A	N/A	N/A	1.13	1.70	2.02	2.25
	50	5.92	2.23	20,000	1,000	1,089	21,937	N/A	N/A	N/A	0.92	1.55	1.87	2.07
16	50	6.85	3.71	20,000	1,000	589	12,782	N/A	N/A	N/A	1.70	2.53	3.07	3.30
	50	6.98	6.45	20,000	1,000	576	4,151	N/A	N/A	N/A	1.74	2.84	3.87	4.84
	50	7.00	7.61	20,000	1,000	464	3,811	N/A	N/A	N/A	2.16	3.67	5.10	6.35

Mixture	Temp.	AV	Max Rut Depth	Max Passes	N pc	Slope 1	Slope 2	Slope 3	SIP	SIP Rut	Rut 1000	Rut 5000	Rut 10000	Rut 15000
17	50	5.35	2.51	20,000	1,000	956	15,773	N/A	N/A	N/A	1.05	1.55	1.84	2.08
	50	5.78	3.07	20,000	1,000	685	16,701	N/A	N/A	N/A	1.46	2.17	2.52	2.86
	50	5.24	2.61	20,000	1,000	1,060	13,570	N/A	N/A	N/A	0.94	1.50	1.88	2.18
18	50	5.73	2.35	20,000	1,000	914	20,363	N/A	N/A	N/A	1.09	1.61	1.93	2.25
	50	5.33	2.37	20,000	1,000	1,035	17,576	N/A	N/A	N/A	0.97	1.52	1.80	2.13
	50	6.06	2.57	20,000	1,000	1,016	16,514	N/A	N/A	N/A	0.99	1.66	2.01	2.33
19	50	5.07	4.41	20,000	1,000	684	8,835	N/A	N/A	N/A	1.46	2.72	3.46	3.94
	50	5.07	3.58	20,000	1,000	809	12,131	N/A	N/A	N/A	1.24	2.34	2.80	3.19
	50	5.02	3.41	20,000	1,000	778	11,954	N/A	N/A	N/A	1.29	2.16	2.70	3.08
20	50	5.57	1.73	20,000	1,000	965	35,235	N/A	N/A	N/A	1.04	1.31	1.58	1.71
	50	6.01	1.75	20,000	1,000	1,077	32,591	N/A	N/A	N/A	0.93	1.29	1.44	1.60
	50	6.59	2.25	20,000	1,000	990	18,855	N/A	N/A	N/A	1.01	1.45	1.71	1.93

Temp: Temperature of the test in °C, Max Rut Depth: Maximum Rutting Depth in mm, Max Passes: Maximum Number of Passes Reached, N Pc: Post Compaction Point, Slope 1: Post Compaction Slope, Slope 2: Creeping Slope, Slope 3: Stripping Slope, SIP: Stripping Inflection Point, SIP Rut: Rutting at SIP in mm, Rut 1000: Rutting at 1,000 passes in mm, Rut 5000: Rutting at 5,000 passes in mm, Rut 10000: Rutting at 10,000 passes in mm, Rut 1500: Rutting at 15,000 passes in mm

4.2 TYPE OF MIXTURE EFFECT

Different HMA/WMA mixtures were tested at variable temperatures. Figure 4.1 depicts the maximum rutting depth and number of wheel passes reached for each mixture tested at different temperature.

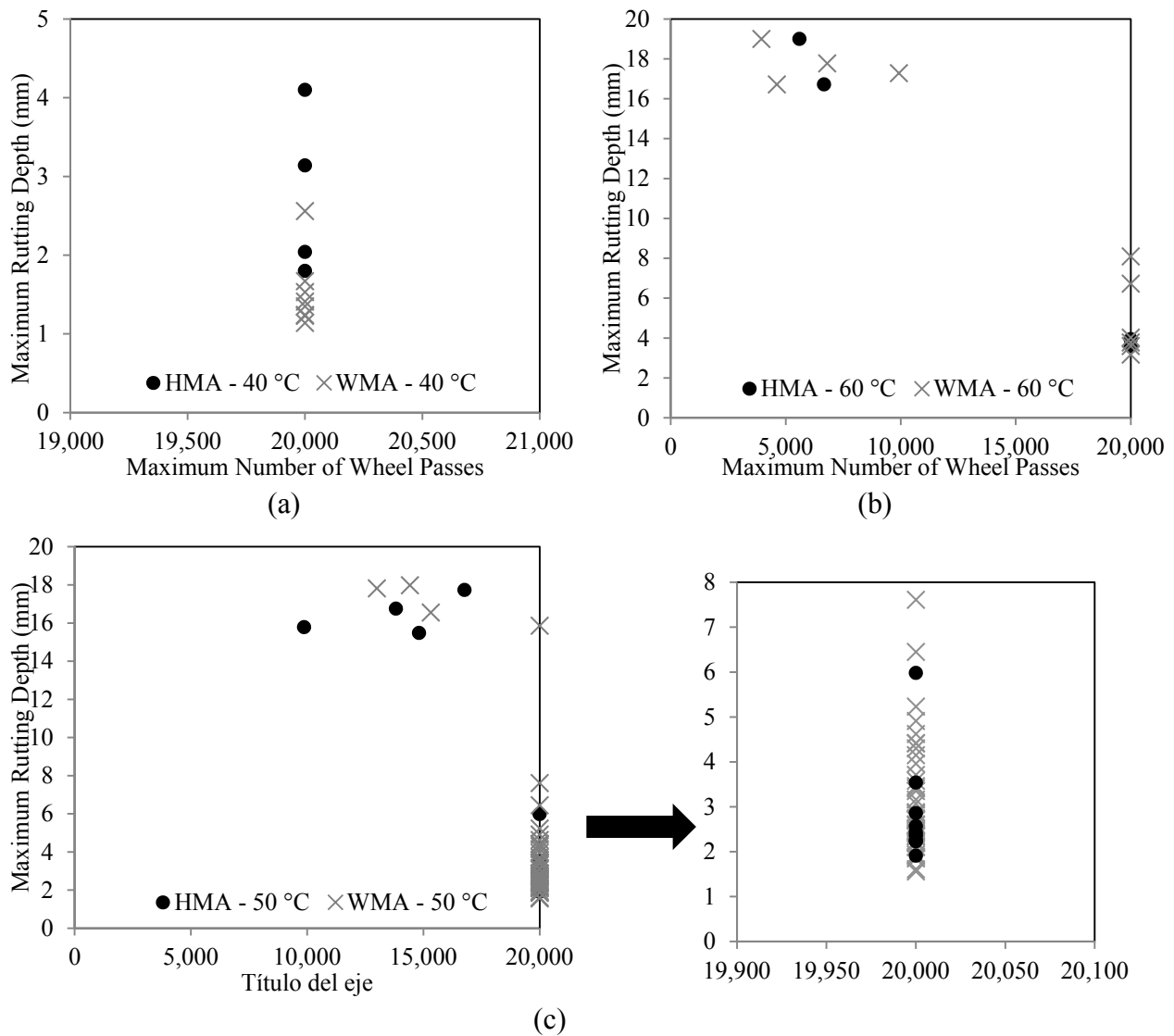

Figure 4.1 HMA/WMA Maximum Impression Vs Maximum Wheel Passes at (a) 40 °C (b) 60 °C (c) 50 °C

From Figure 4.1(a) it can be observed that WMA mixtures performed better at 40 °C with maximum rutting depths less than 2 mm. with only one test above this value. Differently, HMA mixtures maximum rutting depths oscillates between 2 and 4 mm. with inferior performance. Neither HMA nor WMA mixtures failed before the test ended.

HMA/WMA mixtures tested at 50 °C are depicted in Figure 4.1(c) showing more consistency in HMA results. It can be observed that either HMA or WMA mixtures reached in some cases the maximum rutting depth criteria adopted by several transportation agencies (12.5 mm. or 0.5 inches). When HMA/WMA mixtures failed it was observed that WMA last longer in the test with only one test reaching the 20,000 passes. As mentioned before, HMA mixtures showed consistency results when maximum rutting depth criteria was not reached. Results mostly oscillate between 2 and 3.5 mm. rutting depth. In the other hand, WMA mixtures had a significant variation in HWTD results oscillating from 1.5 mm to 5 mm. Differently from mixtures tested at 40 °C, HMA/WMA performance at 50 °C may be related to the type of aggregate, binder PG, gradation or the AV contents in each test. The effect of this parameters combined with the type of mixture will be analyzed further.

Finally, as shown in Figure 4.1(b) HMA/WMA mixtures tested at 60 °C showed a significant variance in the results that may be attached to the parameters mentioned above. In addition, it can be seen that water temperature is clearly affecting the performance of AC mixtures in HWTD test. No significant difference was observed when HMA/WMA mixtures were tested at 50 or 60 °C. Otherwise, when mixtures were tested at 40 °C WMA performed better.

As mentioned above, HWTD results are expressed also in post-compaction, creep and strip slope. Figure 4.2 depicts the effect of test temperature in the post-compaction slope for HMA/WMA mixtures.

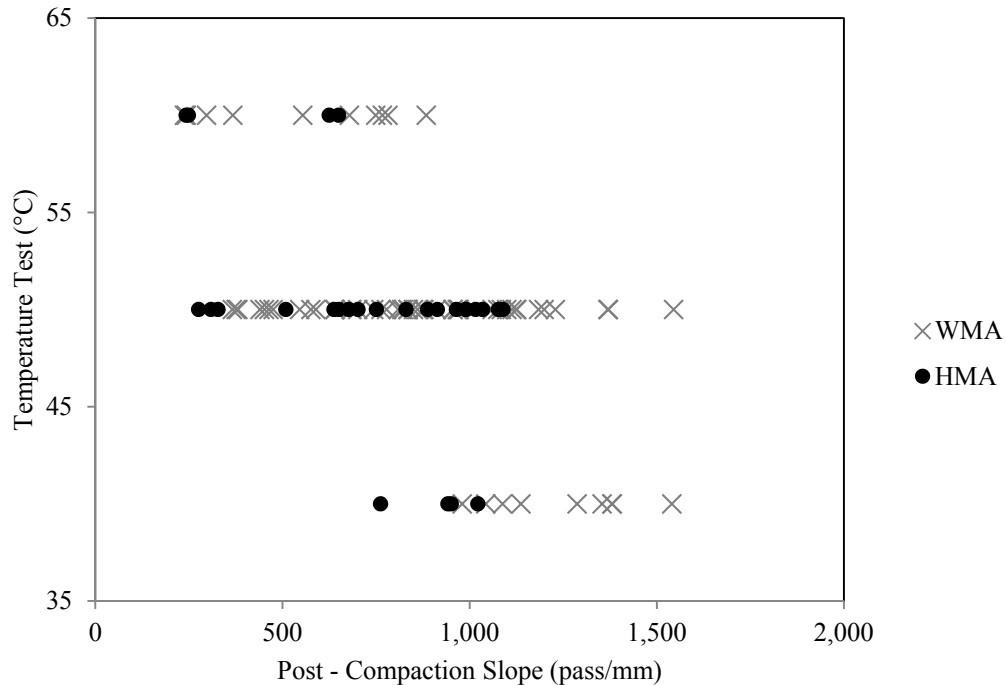

Figure 4.2 HMA/WMA Post-Compaction Slope due temperature test

As shown in previous figure, WMA mixtures showed better results in terms of post-compaction slope at three different temperature tests. This means, HWTD test takes a higher number of wheel passes to densify WMA samples. Test temperature is clearly affecting post-compaction slope in both cases.

In terms of creep slope, Figure 4.3 shows consistency and better results for WMA mixtures at 40 °C test temperature. For 50 °C, HWTD results for HMA mixtures showed three different sections of creep slopes. As stated before, this gap may be related to different parameters in the design mixture or related to the AV contents of the samples. WMA mixtures showed more consistency in the results but same performance trending as HMA mixtures was observed. Same

observation was made for HMA/WMA mixtures tested at 60 °C. As post-compaction slope, creep slope is affected by temperature test.

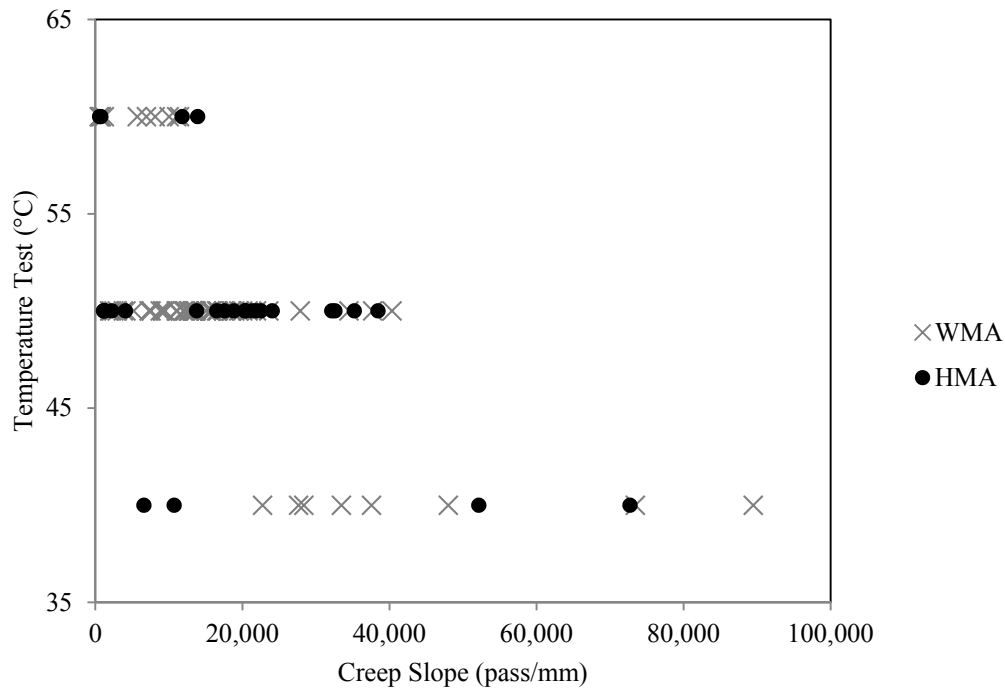

Figure 4.3 HMA/WMA Creep Slope due temperature test

Figure 4.4 depicts the stripping slope results for HMA/WMA that experienced moisture damage in HWTD test. No sign of stripping was observed for mixtures tested at 40 °C. Close results were observed between WMA and HMA mixtures at 50 °C. No significant difference was observed between stripping slope results at 50 °C. For 60 °C, a significant difference was observed between HMA mixtures and two WMA mixtures. Alike, these two mixtures showed better stripping slope results than HMA/WMA mixtures tested at 50 °C.

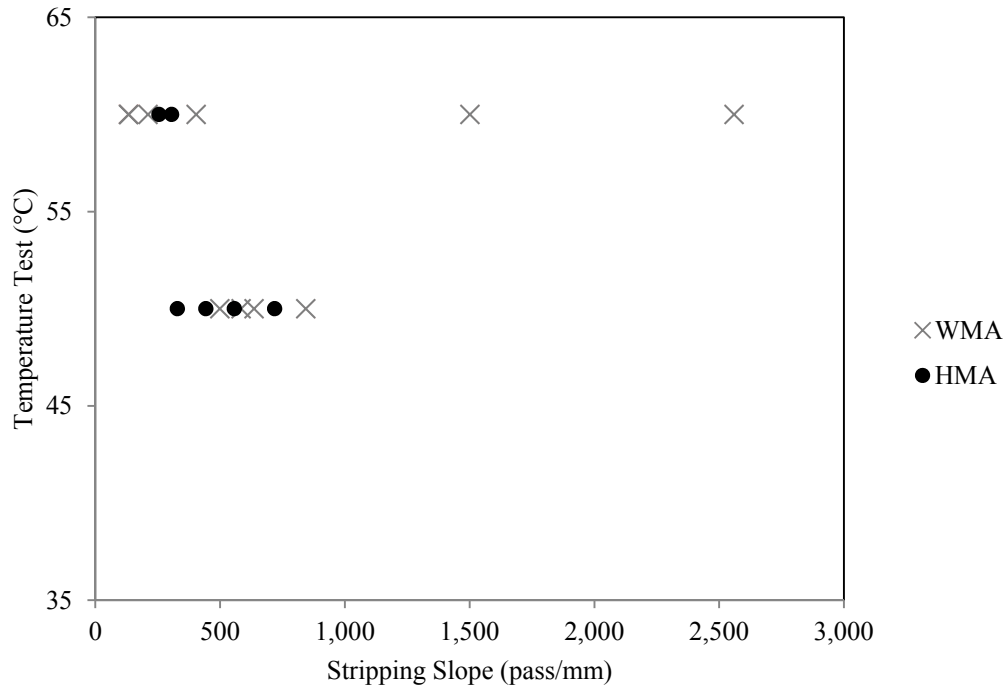
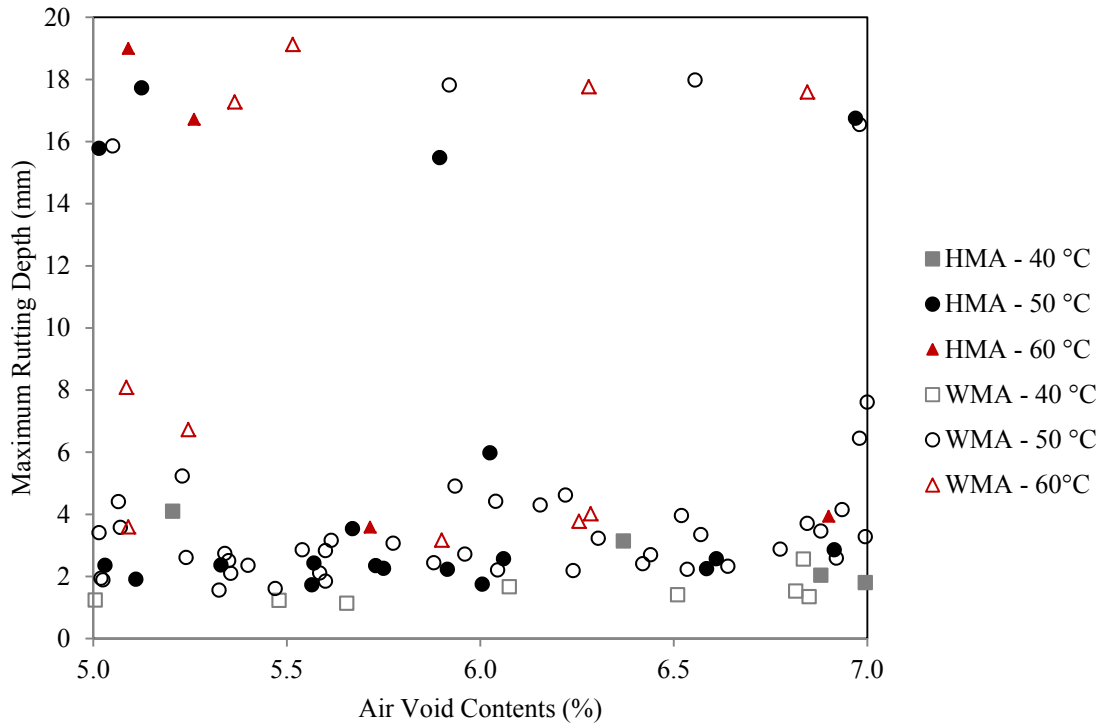

Figure 4.4 HMA/WMA Stripping Slope due Temperature Test

To analyze the effect of air void contents in HMA/WMA mixtures, three ranges of AV contents were defined to observe the effect of this parameter in the tested samples. Range 1 (R1), Range 2 (R2) and Range 3 (R3) were defined as 5.0 - 5.5 %, 5.5 – 6.5 % and 6.5 – 7.0 % AV contents accordingly.

Figure 4.5 express the maximum rutting depths for each HMA/WMA mixture tested with its corresponding AV contents and temperature test.



(a)

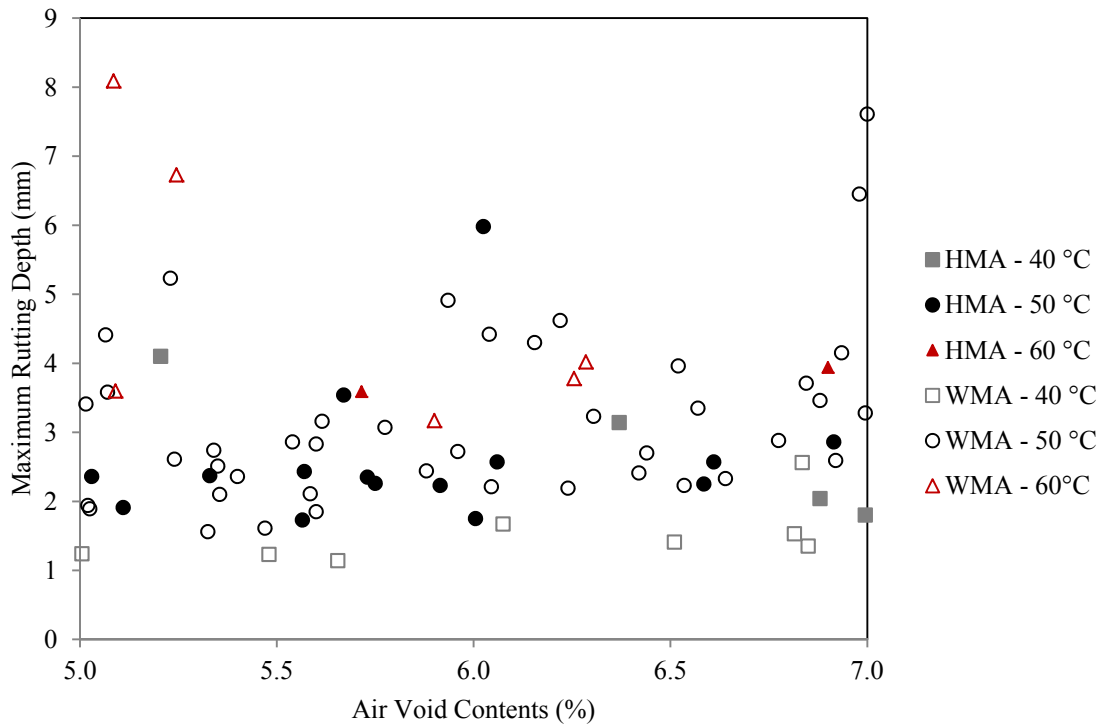

(b)

Figure 4.5 HMA/WMA Maximum Rutting Depth according to AV contents (a) 0 – 20 mm. scale (b) 0 – 9 mm. scale

From previous figures, WMA mixtures tested at 40 °C did not show sensitivity to AV contents. Same results were observed in the three AV range defined. For HMA mixtures tested at that temperature, better results were observed in the third range with insignificant variation in the maximum rutting depth. It may be assumed that HMA/WMA mixtures tested at 40 °C are not sensitive to AV contents variation. Mixtures tested at 50 °C showed high variability for both type of mixtures. Stripping was observed in HMA/WMA mixtures in the three AV ranges defined. No relationship between AV contents and maximum rutting depths was observed for HMA/WMA mixtures tested at 50 °C. Finally, HMA mixtures in R2 and R3 did not show stripping while two tests showed stripping in R1. For WMA mixtures, stripping was observed in the three AV ranges. Anyhow, best performance of samples was observed in R2.

Finally, HMA/WMA mixtures did not show a solid correlation between AV contents and type of mixture when HWTD was conducted at 40 and 50 °C. For 60 °C, results showed a fair improvement in HWTD results when samples were in R2.

4.2.1 Type of Mixture and Gradation

As discussed in Chapter 3, HMA/WMA mixtures were differentiated by gradation using the maximum density line and the corresponding areas above and below the line. It was defined that five of the six HMA mixtures were finer mixtures. For WMA mixtures, three of the fourteen mixtures were defined as finer mixtures. Figure 4.6 depicts the generalized HWTD results according the type of mixture and gradation tested at different water bath temperatures for HMA/WMA mixtures without signs of stripping.

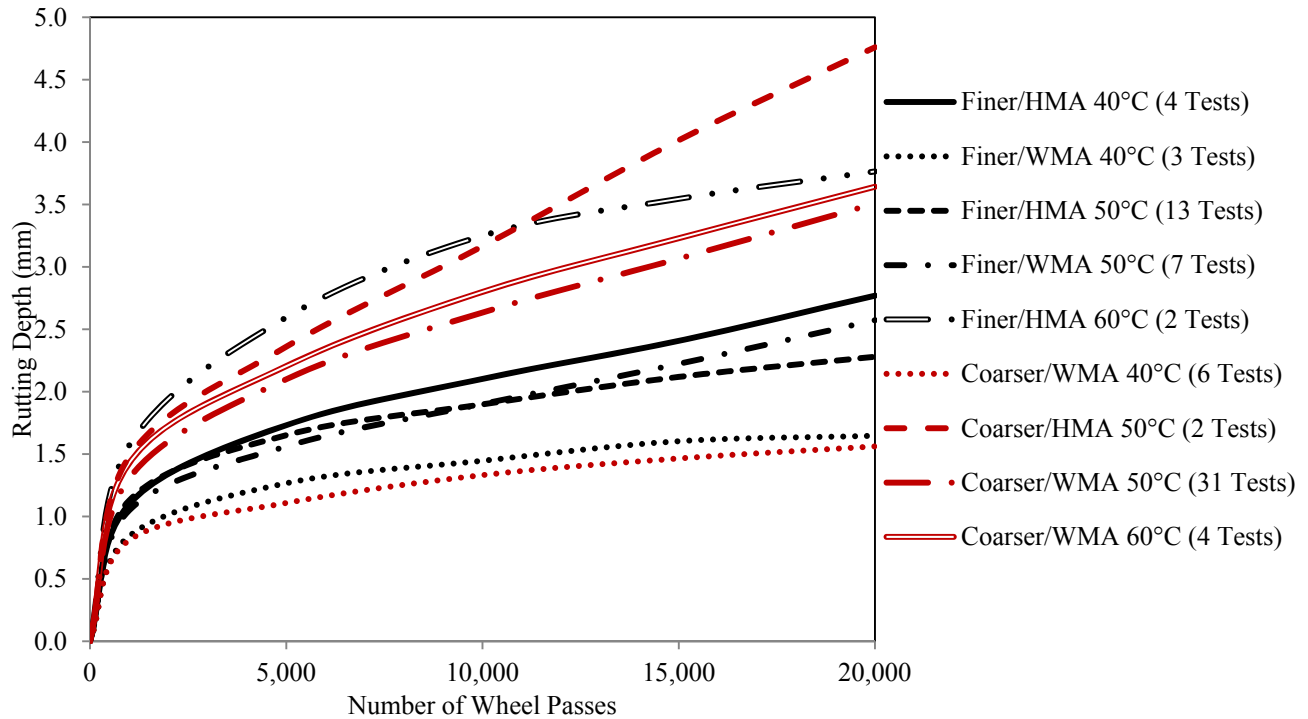

Figure 4.6 Type of Mixture and Gradation HWTD results due test temperature

Finer and coarser WMA mixtures performed better than HMA mixtures at 40 °C. No significant difference was observed in previous figure between WMA finer and coarser mixtures at this temperature with a fairly better performance in coarser WMA mixtures. In the other hand, finer HMA mixtures experienced higher post-compaction and rutting impressions. For this type of mixtures, it was observed that HWTD results showed improvement when temperature increases from 40 to 50 °C. Due the high variation of amount replicates tested between finer HMA mixtures tested at 40 and 50 °C, these results may not represent the real behavior of finer HMA mixtures tested at 40°C. When HWTD was conducted at 50 °C, previous figure shows better HWTD results for finer mixtures regardless the type of mixture. Anyhow, HMA mixtures performed better than WMA mixtures at finer gradations, nor the case for coarser gradations.

For mixtures without stripping tested 60 °C, finer HMA mixtures showed better creep slopes with a higher post-compaction impression. A low creep slope results in coarser WMA mixtures may lead to increase the susceptibility to strip. From previous figure, finer mixtures showed better performance when type of mixtures were discretize by gradations.

The following table summarizes the number of tests with stripping for the different type of mixtures and gradations.

Table 4.2 HMA/WMA Gradation Test in Presence of Stripping

Type of Mixture	Gradation	Temperature (°C)	No. of test	Tests without stripping	Tests with stripping	Average Pass Fail
HMA	Finer	40	4	4	0	N/A
		50	17	13	4	13,816
		60	4	2	2	6,132
	Coarser	40	0	0	0	N/A
		50	2	2	0	N/A
		60	0	0	0	N/A
WMA	Finer	40	3	3	0	N/A
		50	15	11	4	15,681
		60	4	2	2	4,277
	Coarser	40	6	6	0	N/A
		50	31	31	0	N/A
		60	6	4	2	8,358

As discussed above, when HMA/WMA mixtures were only under rutting distress it was found that finer mixtures showed better results. From previous table, HMA/WMA coarser mixtures did not show sign of stripping at 40 and 50 °C. Otherwise, HMA/WMA finer mixtures showed stripping at 50 °C. At 60 °C, 50 percent of the finer mixtures failed compared to the 33 percent of the coarser mixtures. Similarly, average pass fail showed that coarser mixtures tend to fail later than finer mixtures at this temperature.

Finally, it was found that finer gradation in HMA/WMA mixtures perform better when rutting is the only distress in the test. In the stripping phase, coarser gradation mixtures had better behavior.

4.2.2 Type of Mixture and Type of Aggregate

As discussed in chapter 3, seven types of aggregates were differentiated in the twenty HMA/WMA mixtures collected. Table 4.2 discretizes the type of mixtures related to the type of aggregate and test temperature.

Table 4.3 Type of Mixture and Type of Aggregate HWTD Matrix

Type of Mixture	Type of Aggregate	Temperature (°C)	No. of test	Tests without stripping	Tests with stripping
HMA	Basalt	40	2	2	N/A
		50	7	7	N/A
		60	2	2	N/A
	Quartzite	50	3	3	N/A
	River Deposits	50	3	3	N/A
	Sand and Gravel	50	2	2	N/A
	Shale	40	2	2	N/A
		50	4	0	4
		60	2	0	2
WMA	Basalt	50	3	3	N/A
	Dacite	40	1	1	N/A
		50	4	0	4
		60	2	0	2
	Limestone	40	2	2	N/A
		50	4	4	N/A
		60	2	0	2
	River Deposits	40	4	4	N/A
		50	9	9	N/A
60		4	2	2	
Sand and Gravel		40	2	2	N/A
		50	26	26	N/A
	60	2	2	N/A	

As shown in Table 4.3, HMA/WMA mixtures did not show signs of stripping for mixtures with any of the seven types of aggregates when HWTD was conducted at 40 °C. For 50 °C, HMA/WMA mixtures only failed for HMA with shale and WMA with dacite. At 60 °C, shale and dacite still failed for HMA/WMA mixtures. When WMA mixtures were in presence of limestone and river deposits aggregates, stripping was observed.

Figure 4.7 depicts HWTD results curves for HMA/WMA at 50°C for basalt, river deposits, quartzite, limestone and sand and gravel. These aggregates were selected since no stripping was observed at the standard test temperature.

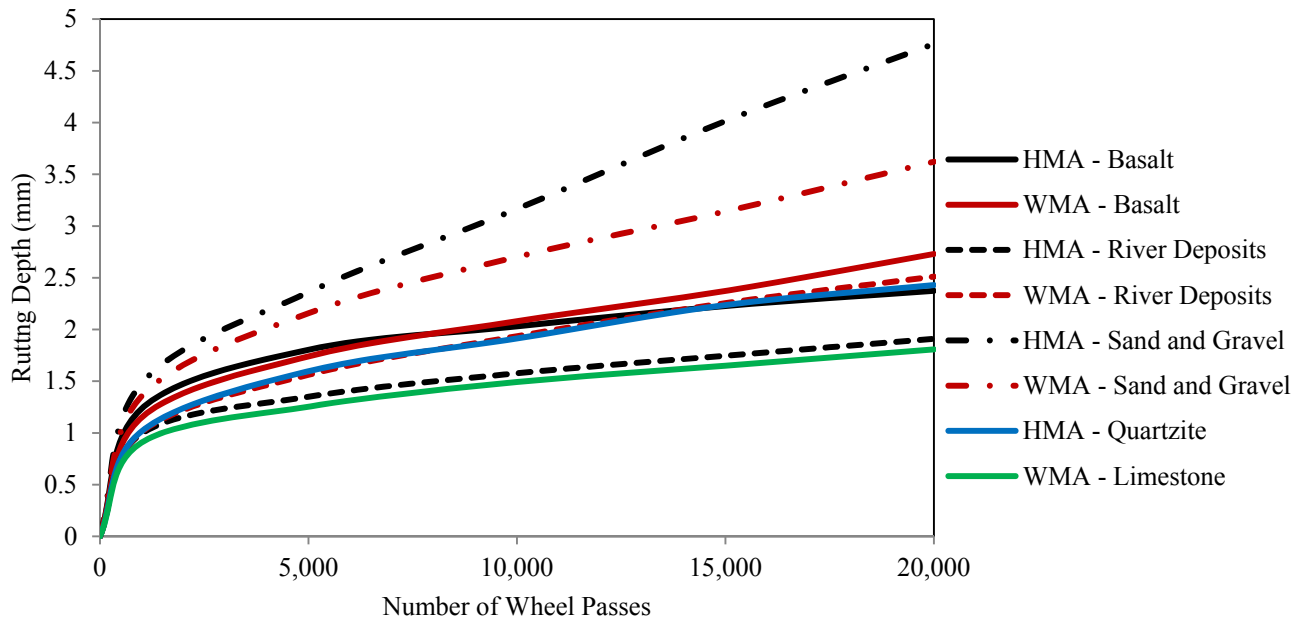

Figure 4.7 HMA/WMA and Type of Aggregate HWTD results at 50 °C

From previous figure it can be observed that WMA mixture with limestone and HMA mixture with river deposits aggregate performed better. Basalt for the two types of mixtures, river deposits in WMA mixtures and quartzite in HMA mixtures performed similarly. Clearly, sand and gravel aggregate showed the higher rutting depths in both type of mixtures compared to the other type of aggregates. The amount of rutting in the post-compaction phase for sand and gravel

aggregates is high with low creeping slopes. In figure, sand and gravel behaved better for WMA mixtures, basalt for HMA mixtures and river deposits aggregate in HMA mixtures.

Finally, it was noticed that dacite and shale are weak aggregates when HWTD is the test. Sand and gravel did not showed stripping but performance is lower compared to river deposits, quartzite and basalt that performed similarly. Limestone showed the best results when the standard test was conducted. No close relationship was observed between type of mixtures and type of aggregate was observed.

4.2.3 Type of Mixture and Binder Performance Grade

Different types of HMA/WMA mixtures were collected with different binder PG. Previous literature address that performance of HWTD in AC mixtures is related to this parameter. It was found by researchers that higher binder grades experienced less rut in HWTD. Four different types of binders PG were studied as shown in the following table.

Table 4.4 Type of Mixture and Type of Binder PG HWTD Matrix

Type of Mixture	Binder PG	Temperature (°C)	No. of test	Tests without stripping	Tests with stripping
HMA	PG 64-28	40	4	4	N/A
		50	8	4	4
		60	4	2	2
	PG 70-22	50	6	6	N/A
	PG 76-22	50	5	5	N/A
	PG 64-28	50	3	3	N/A
WMA	PG 70-22	40	2	2	N/A
		50	6	6	N/A
		60	2	2	N/A
	PG 76-22	40	6	6	N/A
		50	31	31	N/A
		60	6	2	4
	PG 76-28	40	1	1	N/A
		50	4	0	4
		60	2	0	2
		PG 76-22*	50	2	2

(*) Modified Polymer

Table 4.4 summarizes the type of mixture related to the type of binder PG used in the collected mixtures for different test temperatures, along with the number of testes performed. In addition, test that reached stripping phase are mentioned.

It can be observed that binder PG70-22 and binder PG76-22 performed well in the HWTD test. No signs of stripping were observed for HMA/WMA mixtures tested at the standard temperature. For 60 °C, binder PG70-22 passed in all the tests performed. Differently, binder PG76-22 reached stripping in the 66 percent of the mixtures tested. Binder PG 76-28 failed in all t50 and 60 °C tests. Previous analysis showed that some aggregates performed badly in the HWTD. Poor performance for high binder grades may be related to this effect. As expected, no signs of stripping were observed in all mixtures tested at 40 °C. Figure 4.8 depicts the generalized HWTD results obtained for mixtures without stripping at the standard test temperature.

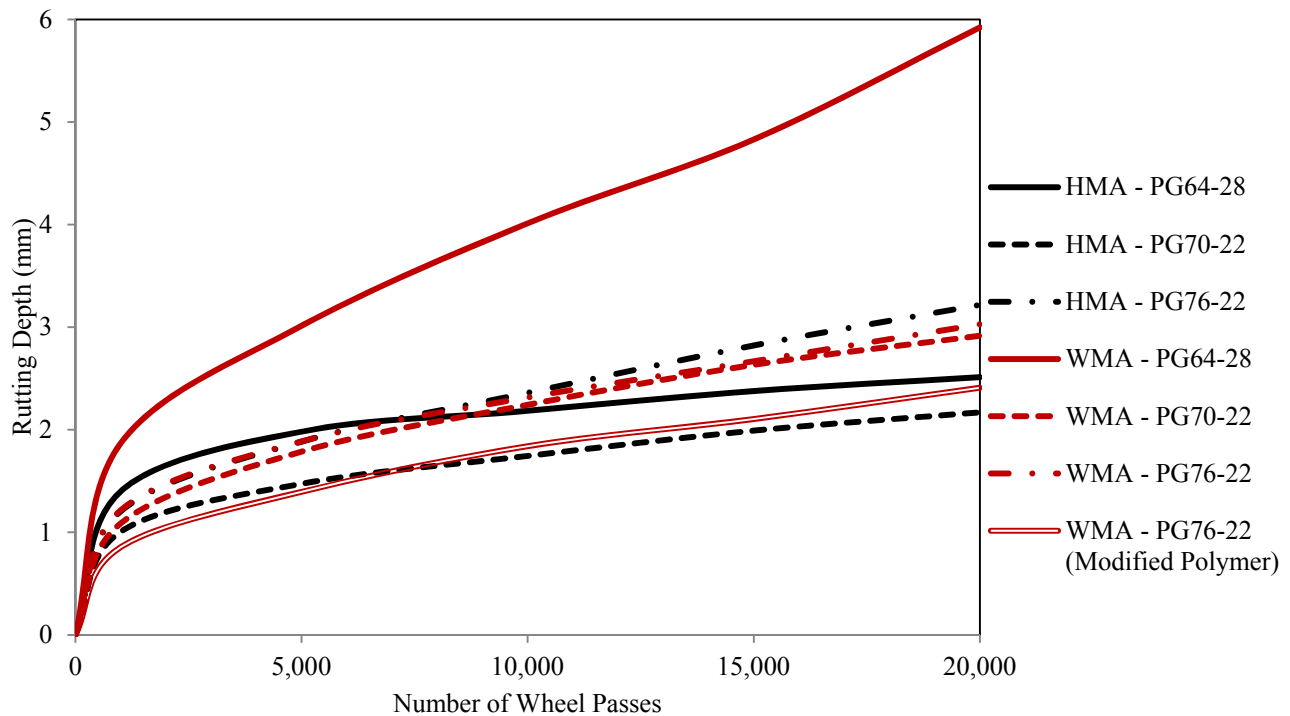

Figure 4.8 HMA/WMA and Binder PG HWTD Results at 50 °C

From figure above, a significant gap can be observed between WMA mixtures with PG64-28 and other mixtures tested. Same binder PG was used in HMA mixtures with an important improvement in HWTD rutting results. A significant difference between post compaction and creeping phase was observed. Excluding the modified polymer, HMA mixtures showed better results. In HMA mixtures PG70-22 showed better results in the three binders tested. Similarly, WMA mixtures with PG 70-22 showed better performance. From previous figure, it can be observed that creep slopes for HMA mixtures with PG64-28 and PG70-22 are high. WMA mixture with modified polymer showed improvement in HWTD results compared to the same binder without a modified polymer. From previous results, it may be concluded that HMA/WMA mixtures performance is sensitive to the binder PG.

4.3 TYPE OF GRADATION EFFECT

As discussed in chapter 3, AC mixtures were discretized in finer and coarser gradations. It was found that 9 of the 20 mixtures were finer gradations. Figure 4.9 depicts the maximum rutting depth along with the maximum number of wheel passes for HMA/WMA finer and coarser mixtures at different test temperatures.

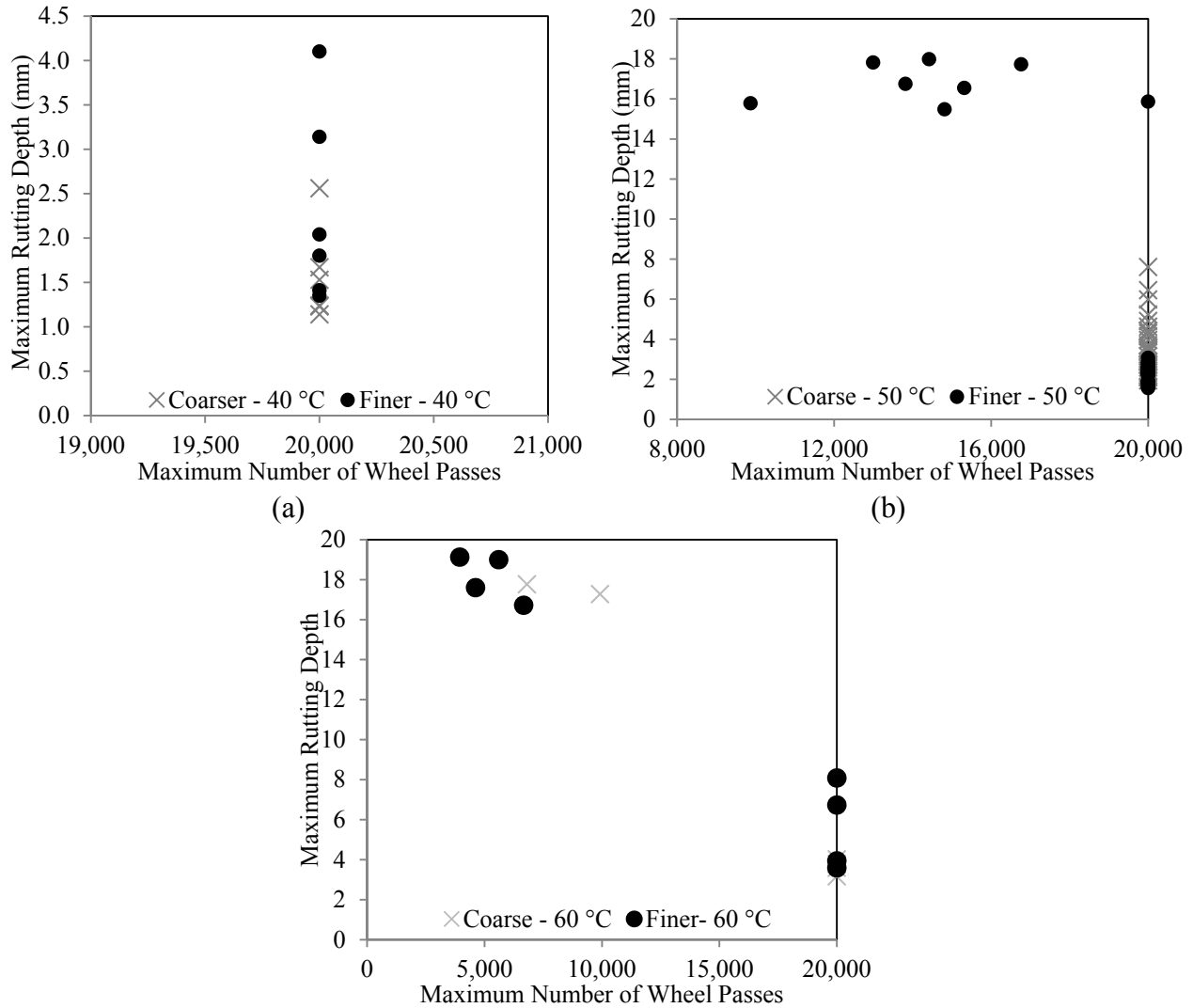

Figure 4.9 Type of Gradation Maximum Impression Vs Maximum Wheel Passes at (a) 40 °C (b) 50 °C (c) 60 °C

As shown in previous figure, there is a significant difference in HWTD results between HMA/WMA finer and coarser mixtures. For 40 °C, Coarser mixtures performed better with a maximum rutting depth of 2.5mm differently from finer mixtures with rutting depths close to 4.5 mm. In addition, when mixtures were tested at 50 °C same trending was observed in the results. A significant difference was observed between coarser and finer mixtures. None of the coarser mixtures failed in the HWTD test assuming the general criteria (12.5 mm maximum rutting depth). Finer mixtures reached the stripping phase at this temperature and collapsed before the end of the test. It was observed that finer mixtures with stripping mostly failed around the 12,000 and 17,000 passes. Differently, coarser mixtures only reached the creeping phase with rutting depths below 8 mm. For 60 °C, coarser and finer mixtures failed. Anyway, a larger number of finer mixtures failed with higher impression at lower number of passes. For mixtures tested at this temperature with no signs of stripping, coarser mixtures showed again better performance with rutting depths no larger than 4 mm. as shown in previous figure.

From previous figure it can be concluded that coarser mixtures have better performance than finer mixtures in the three defined temperatures.

A close view of how these mixtures behaved in the three HWTD phases are depicted in the following figure. Figure 4.10 depicts post-compaction slopes for coarser and finer mixtures at different temperatures.

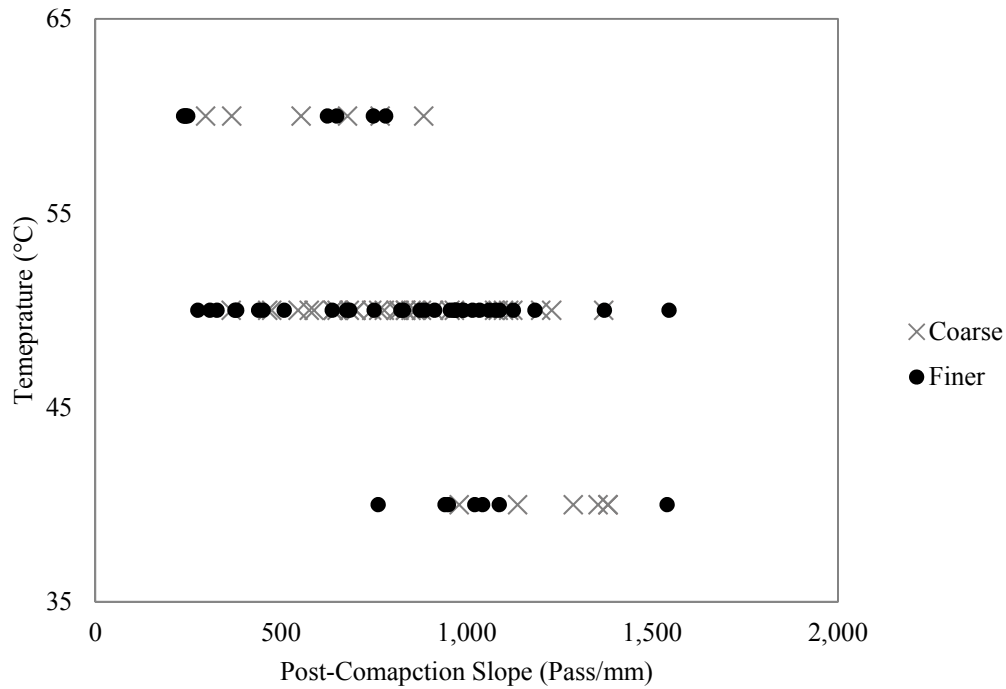

Figure 4.10 Type of Gradation Post-Compaction Slope due temperature test

From previous figure it can be observed no significant difference between post-compaction slopes between finer and coarser mixtures at 50 and 60 °C. The same spectra were observed in both gradations at these temperatures. For 40 °C, mildly better results were observed for coarser gradations. In addition, previous figure showed the effect of temperature in both of the gradations; lower post-compactions were observed when temperature was increased.

Similarly, the effect of test temperature in creep slopes for HMA/WMA coarser and finer gradations are shown in Figure 4.11.

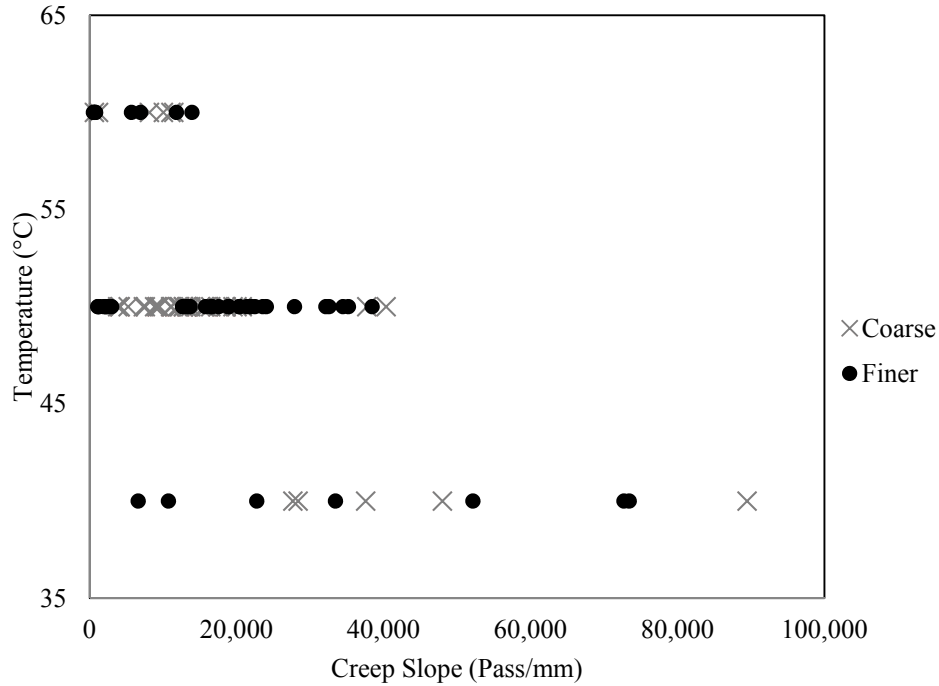

Figure 4.11 Type of Gradation Creep Slope due temperature test

At 40 °C, it was observed a high variability in HWTD results for both gradations. Anyhow, two finer mixtures poorly behaved in terms of creep slope. A particular trending in the results due type of gradation was not observed. For 50 °C, better creep slopes were observed for finer mixtures mostly oscillating from 12,000 to 25,000 passes/mm. Coarser mixtures creeps slopes generally oscillates from 3,000 to 20,000 passes/mm. For mixtures tested at 60°C, a higher consistency in creep slope results was observed for coarser gradations. Anyhow, finer mixtures showed high variability in these results with equal or better results than coarser mixtures.

A significant impact of temperature in creep slopes results was observed for finer mixtures tested at 50 and 60 °C. For coarser mixtures, higher impact of temperature was observed when HWTD was conducted at 40 and 50 °C.

As mentioned above, some of the HMA/WMA mixtures reached the stripping phase in HWTD test. Figure 4.12 shows the different stripping slope results at different temperature test for the different type of gradations defined.

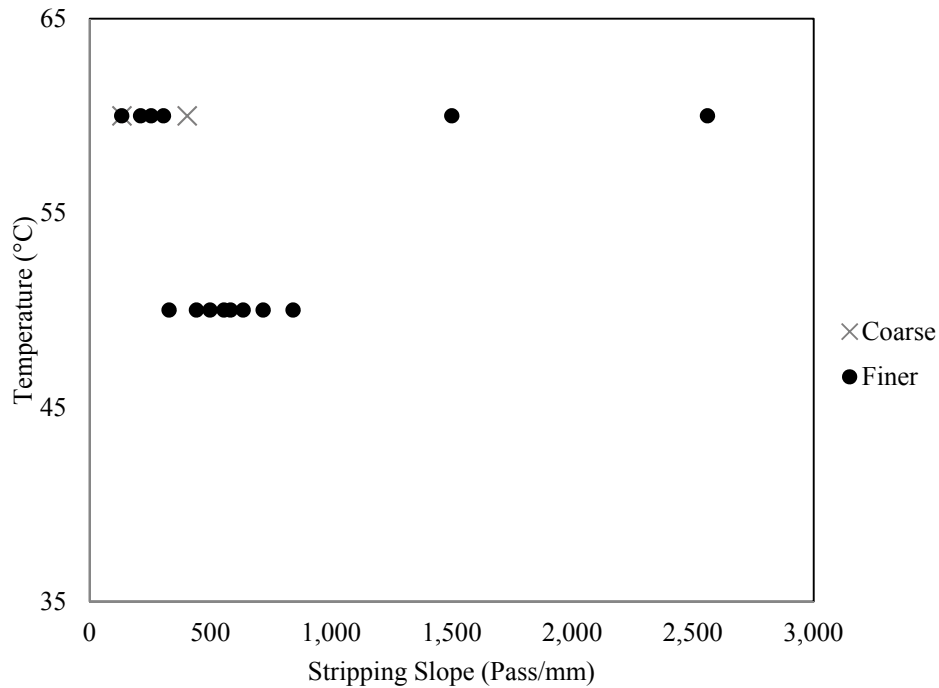
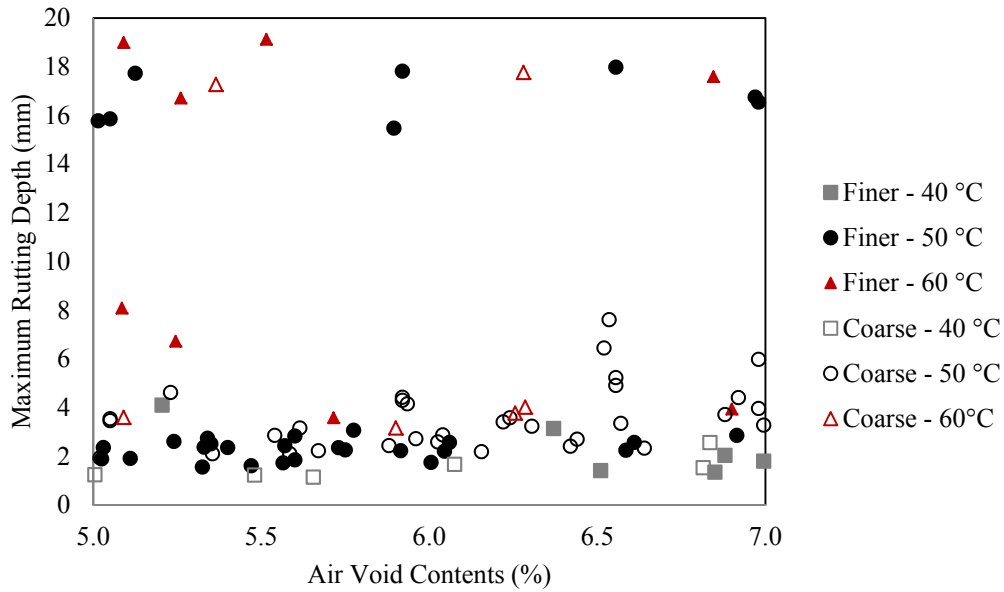

Figure 4.12 Type of Gradation Stripping Slope due temperature test

As shown in previous figure, none HMA/WMA mixture reached the stripping phase at 40 °C. Anyhow, it was observed a significance difference between finer and coarser mixtures for 50 and 60 °C. None coarser mixture reached the mentioned phase at 50 °C. Differently, finer mixtures reached this phase in many cases at this temperature with low stripping slopes. It can be seen that finer mixtures are more sensitive to reach the stripping phase. At 60 °c, either coarser or finer mixtures reached stripping phase. Anyway, only two coarser mixtures compared to six finer mixtures had this distress. Finally, form previous graph it can be observed that temperature is affecting the stripping results in finer mixtures.

As previously described, three air voids ranges were defined in order to analyze the impact of this parameter in AC mixtures. Figure 4.13 depicts the maximum rutting depth according the air void content of the tested samples for the different type of gradations and test temperatures.



(a)

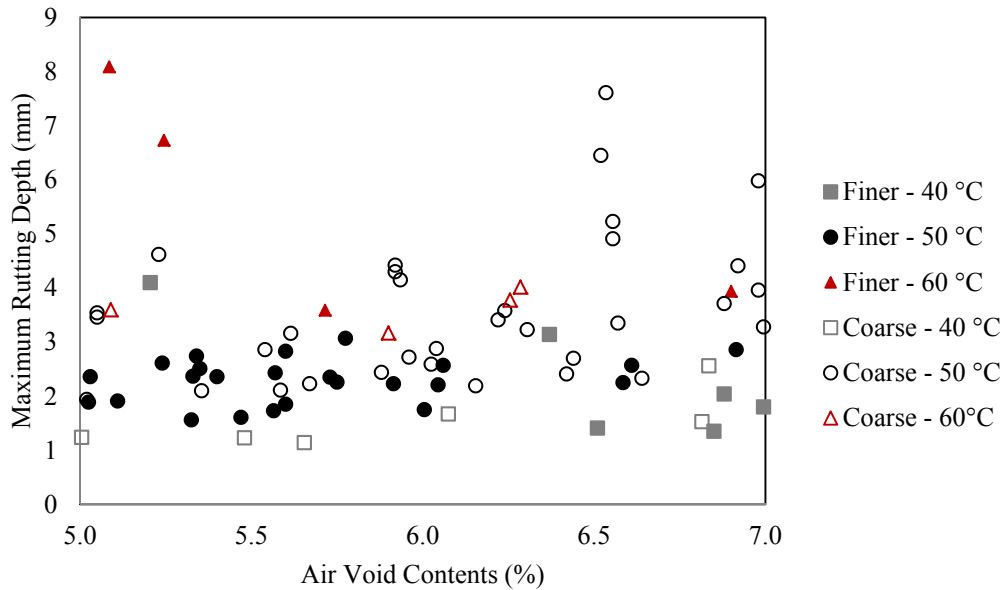

(b)

Figure 4.13 HMA/WMA Maximum Rutting Depth According to AV Contents (a) 0 – 20 mm. scale (b) 0 – 9 mm. scale

In Figure 4.13, it was observed that finer mixtures at 40 °C behaved better in the third air void range. Higher rutting depths were observed in other ranges. When finer mixtures were tested at 50 °C, no significant difference was observed in maximum impression results between the three air voids ranges for creeping and stripping phases. At 60 °C, R1 showed higher impression compared to the others. No stripping was observed in R2 for finer mixtures tested at this temperature. Differently, R3 did show one test with stripping. For coarser mixtures, fairly better results were observed in R1 when mixtures were tested at 40 °C. As discussed, none of the coarser mixtures failed at 50 °C differently from finer mixtures. Anyhow, higher rutting depths were observed in R3. Other two ranges showed similar results at this temperature. At 60 °C, only coarser mixtures were tested in R1 and R2. Same trend was observed for both ranges at this temperature. Finally, generally it can be concluded that R2 showed more consistency and better results in both of the analyzed gradations.

4.3.1 Type of Gradation and Type of Aggregate

As discussed, seven types of aggregates were differentiated in the different HMA/WMA coarser and finer mixtures collected. In previous chapters, it was observed that HWTD results are sensitive to the type of aggregate.

Table 4.5 discretizes the type of gradation related to the type of aggregate and test temperature according with number of tests with and without stripping.

Table 4.5 Type of Gradation and Type of Aggregate HWTM Matrix

Type of Mixture	Type of Aggregate	Temperature (°C)	No. of test	Tests without stripping	Tests with stripping	
Finer	Basalt	40	2	2	N/A	
		50	10	10	N/A	
		60	2	2	N/A	
	Quartzite	50	3	3	N/A	
	River Deposits	50	3	3	N/A	
	Sand and Gravel	50	4	4	N/A	
	Shale	40	2	2	N/A	
		50	4	0	4	
		60	2	0	2	
		Dacite	40	1	1	N/A
			50	4	0	4
			60	2	0	2
	Limestone	40	2	2	N/A	
		50	4	4	N/A	
		60	2	0	2	
Coarser	Sand and Gravel	40	2	2	N/A	
		50	24	24	N/A	
		60	2	2	N/A	
	River Deposits	40	4	4	N/A	
		50	9	9	N/A	
		60	4	2	2	

From previous table, it can be observed that only two types of aggregates failed for finer mixtures gradations at the standard test temperature. As discussed in type of mixture analysis, similar findings were observed for dacite and shale aggregates. Sand and gravel along with river deposits did not fail for 40 and 50 °C test temperature for both of the gradations. For finer mixtures, three other aggregates without stripping were observed (quartzite, basalt and limestone). Comparing basalt and limestone, second one failed at 60 °C. In coarser mixtures, sand and gravel passed the test in three of the test temperatures. Differently, river deposits failed for 60 °C.

Figure 4.14 depicts the generalized HWTD results curves for both gradations at 50°C for sand and gravel, basalt, quartzite, limestone and river deposits. These aggregates were selected since no stripping was observed at the standard test temperature.

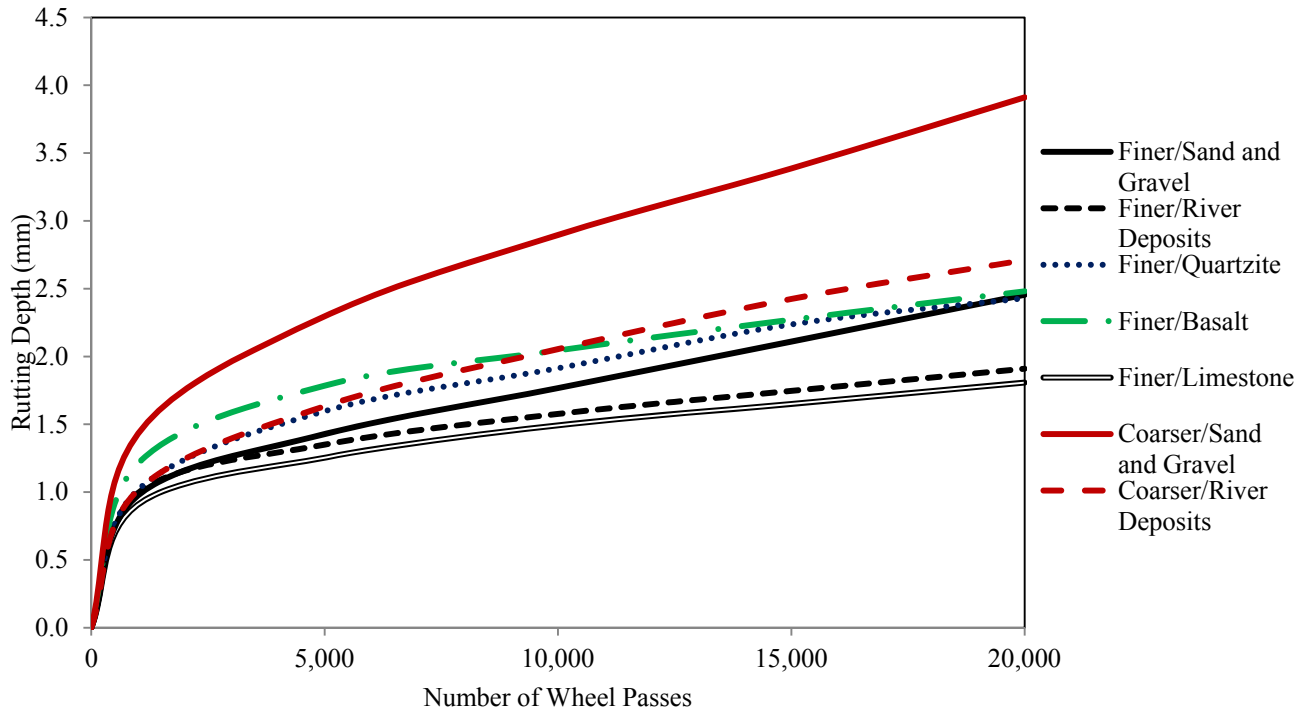

Figure 4.14 Type of Gradation and Type of Aggregate HWTD Results at 50 °C

From previous figure, finer mixtures showed better HWTD curve results for sand and gravel, and river deposits aggregates. Anyhow, the difference between of test performed for finer mixtures and coarser mixtures with these aggregates is significant. For finer mixtures, river deposits showed better results in the creeping phase and similar behavior in the post-compaction phase. Similarly in coarser mixtures, river deposits showed better results with a significant difference in the creeping and post-compaction phase. Comparing finer mixtures and the different type of aggregates, limestone showed better results in the post-compaction and creeping phase and basalt experienced the higher rutting post-compaction depth with good results in the creeping phase. Sand and gravel, and quartzite behaved similar in both phases with lower performance than

previous aggregates. Finally, river deposits showed the same trending as limestone with an insignificant gap in both HWTD phases.

4.3.2 Type of Gradation and Binder Performance Grade

Four different types of binders PG along with different type of gradation were studied as shown in the following table.

Table 4.6 Type of Mixture and Type of Binder PG HWTD Matrix

Type of Mixture	Binder PG	Temperature (°C)	No. of test	Tests without stripping	Tests with stripping	
Finer	PG 64-28	40	4	4	N/A	
		50	8	4	4	
		60	4	2	2	
	PG 70-22	50	6	6	N/A	
		PG 76-22	40	2	2	N/A
			50	14	14	N/A
	60		2	0	2	
	PG 76-28	40	1	1	N/A	
		50	4	0	4	
		60	2	0	2	
	Coarse	PG 64-28	50	3	3	N/A
		PG 70-22	40	2	2	N/A
50			6	6	N/A	
60			2	2	N/A	
PG 76-22		40	4	4	N/A	
		50	22	24	N/A	
		60	4	2	2	
PG 76-22*		50	2	2	N/A	

(*)Modified Polymer

From Table 4.6, it can be observed that none of the binder performance grades selected failed for 40 °C. At 50 °C, two binders PG reached stripping phase (PG64-28 and PG76-28) for finer mixtures. In coarser mixtures no sign of stripping was observed for any of the binder PG's selected. At 60 °C, all binder PG's failed at this test temperature and only one for coarser mixtures. Figure 4.15 depicts the generalized HWTD results for both type of gradations and

different binder PG's at standard temperature test (50 °C) when only rutting phase was experienced.

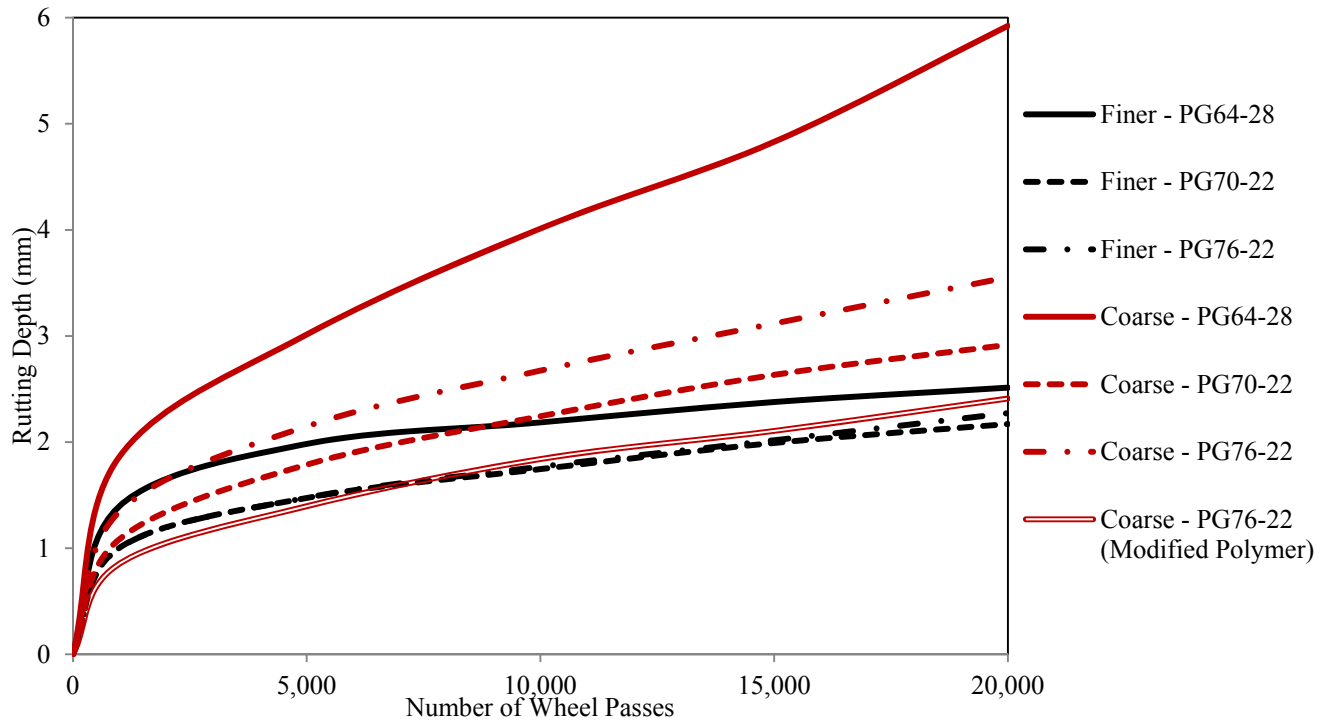
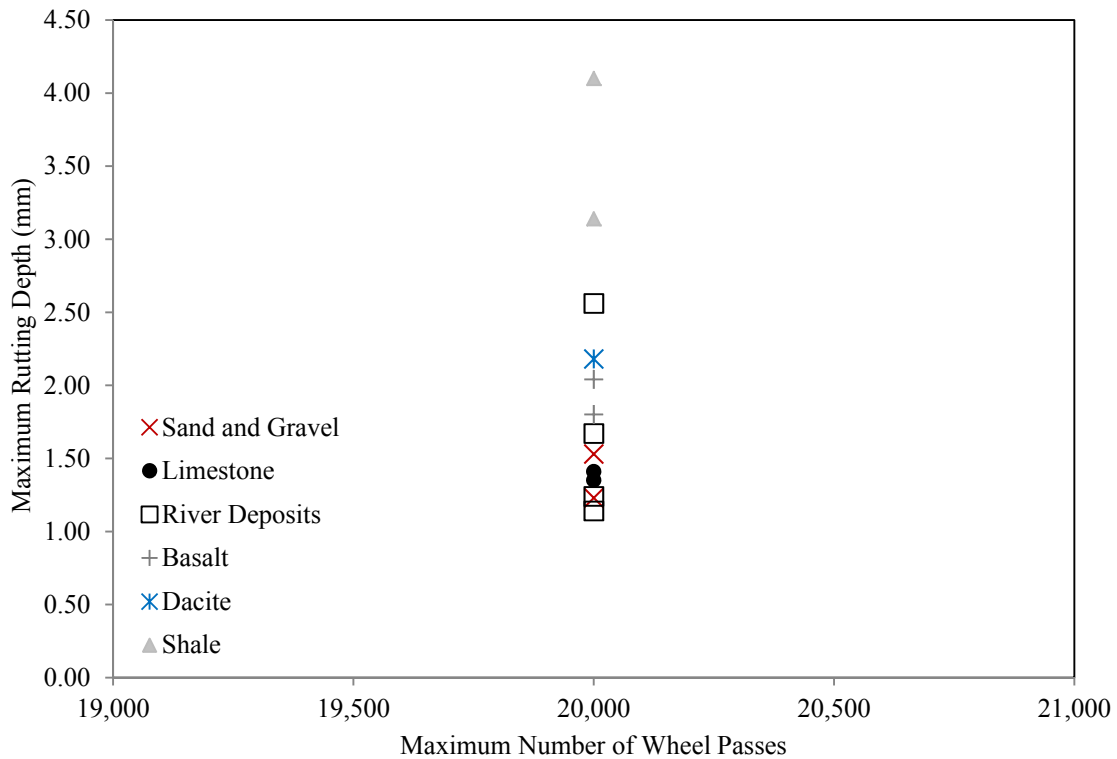

Figure 4.15 Type of Gradation and Binder PG HWTD Results at 50 °C

From previous figure, finer mixtures under different binder PG performed better in HWTD if rutting is the case. No difference was observed between PG70-22 and PG76-22 for finer mixtures. Anyhow, these binders PG's showed better results than PG64-28 for this type of gradation. Less rutting depth in post-compaction phase was observed and similar creep slopes. For coarser mixtures, PG76-22 with the modified polymer showed better results. A significant difference was observed when coarser mixtures were in presence of PG64-28. High post-compaction rutting, low creep slopes and high maximum impression were observed. Similarly, this binder PG showed the worst behavior for finer mixtures. Comparing PG70-22 and PG76-22, better results were observed for PG70-22 in both of the HWTD phases under study.

4.4 TYPE OF AGGREGATE

As observed in chapter 4, when type of aggregate was studied for each of the parameters mentioned, a significant variation in results was observed. Literature review states that harder aggregates perform better in HWTD and the rutting resistance increases. Figure 4.16 depicts the maximum rutting depth and number of wheel passes reached for each type of aggregate (Sand and Gravel, Limestone, River Deposits, Basalt, Dacite and Quartzite) at different test temperatures.



(a)

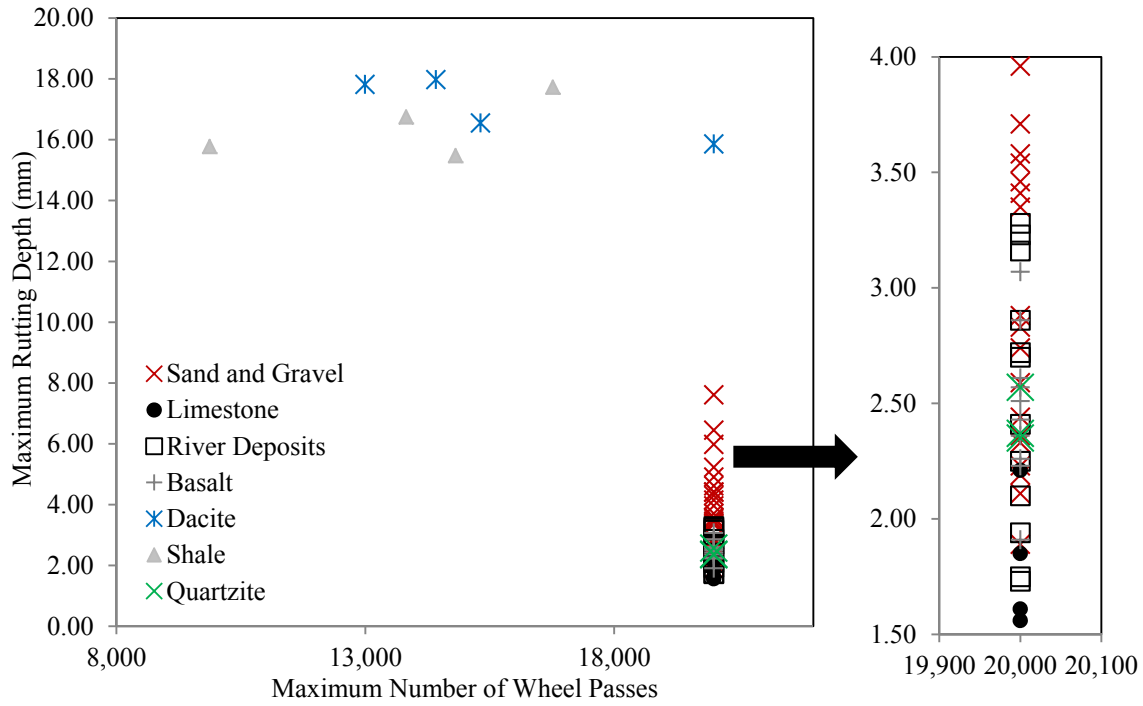

(b)

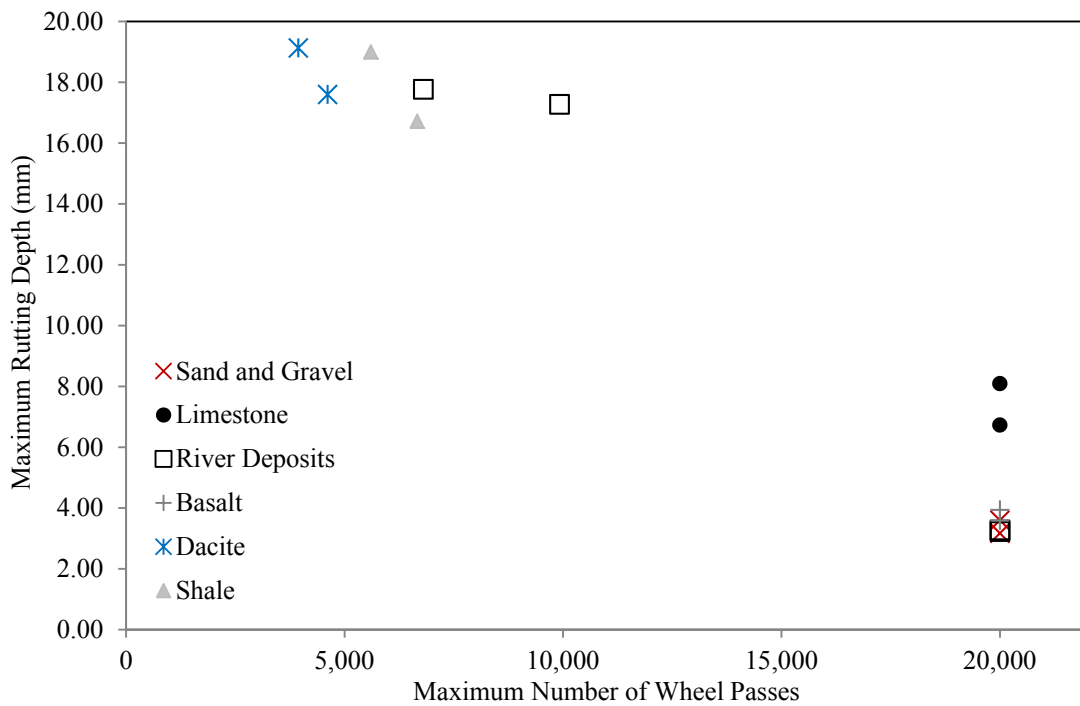

(c)

Figure 4.16 Type of Aggregate Maximum Impression Vs Maximum Wheel Passes at (a) 40 °C (b) 50 °C (c) 60 °C

From Figure 4.16, it can be observed that shale aggregate showed the worst results at 40 °C. Dacite and river deposits exceed the 2 mm. rutting depth while other type of aggregates maximum impression was between 1 and 2 mm. No significant impact the test temperature was observed for all aggregates besides dacite. At 50 °C, shale and dacite failed in all the tests performed. Significant difference was observed compared to other aggregates. Sand and gravel showed higher rutting depths for mixtures below the maximum standard rutting depth (12.5 mm.). Anyhow, this type of aggregate showed a high variability on results. Besides sand and gravel, all other mixtures showed rutting depths below 3.5 mm.

It was observed that river deposits had high variability on HWTD results. Rutting depths oscillated from 1.7 to 3.3 mm. Limestone showed to be the best aggregate at this test temperature with rutting depths lower than 2.3 mm. Quartzite and basalt behaved similar with rutting depths in the average zone (2 to 3 mm.). Similarly, dacite and shale collapsed at 60 °C along with river deposits. High rutting depths and low number of wheel passes was observed for the first two aggregates. Anyhow, river deposits showed tests with good rutting results along with sand and gravel, and basalt. Limestone did not reach the maximum standard rutting depth but high rutting depths were observed. From previous figure can be observed that limestone had higher tendency to reach stripping at this temperature. It can be concluded that dacite and shale are bad aggregates for HWTD test. Outstanding performance was observed for basalt.

Further analysis in the three HWTD phases for the different type of aggregates is depicted in the following figure. Figure 4.17 depicts post-compaction slopes for defined aggregates at different temperatures.

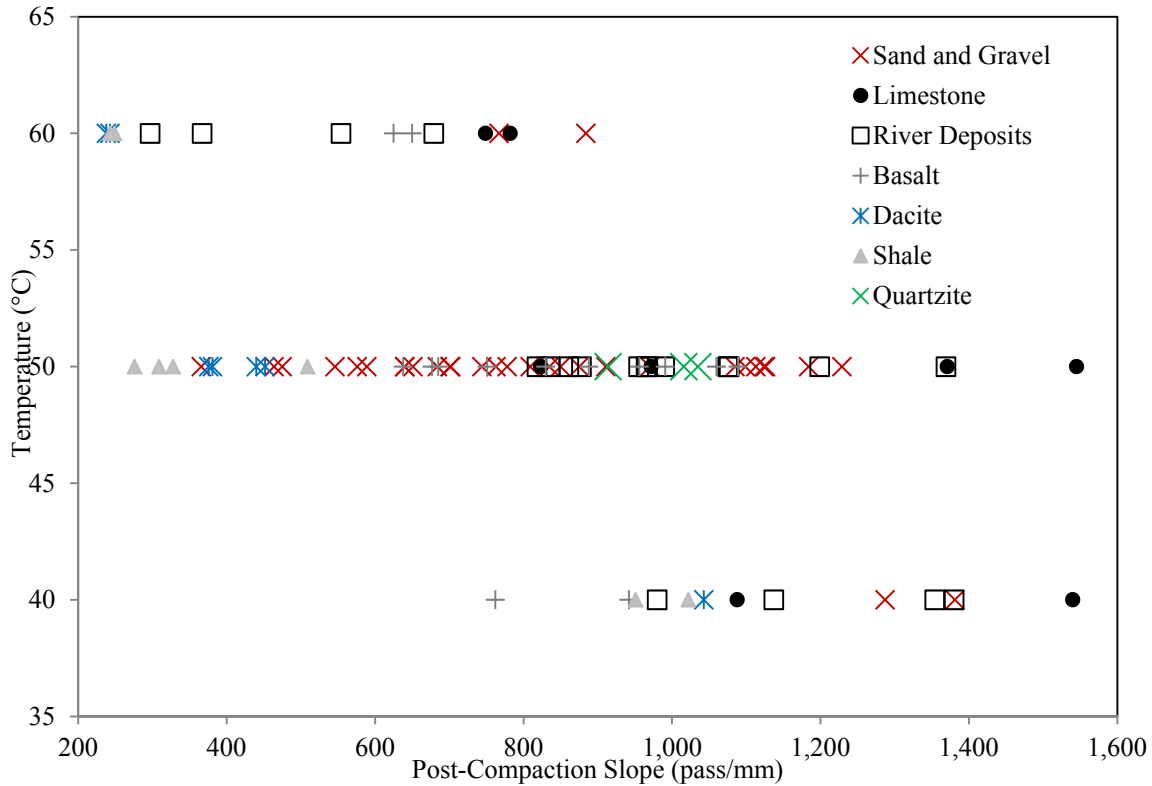

Figure 4.17 Type of Aggregate Post-Compaction Slope due Temperature Test

From previous figure, basalt is having low post-compaction slopes at 40 °C compared to other aggregates. Shale and dacite showed similarly results at this temperature. Best results were observed for sand and gravel in this phase. River deposits and limestone showed variation for post-compaction slopes at this temperature. At 50 °C, dacite and shale significant decrease the post-compaction slopes. Temperature is affecting the post-compaction phase for these aggregates. Similarly, a decrease of slopes was observed for sand and gravel. River deposits, limestone and maintained the trending of results for this phase when temperature was increased with non-significant variation. Quartzite showed post-compaction slopes in the average region of tested aggregates. A significant diminution was observed in the post-compaction slopes when mixtures were tested at 60 °C. Differently, sand and gravel showed for two test better results. This effect may be related to the high variability in sand and gravel results.

For the creeping phase, Figure 4.18 depicts the creep slopes results obtained for the aggregates tested at different test temperatures.

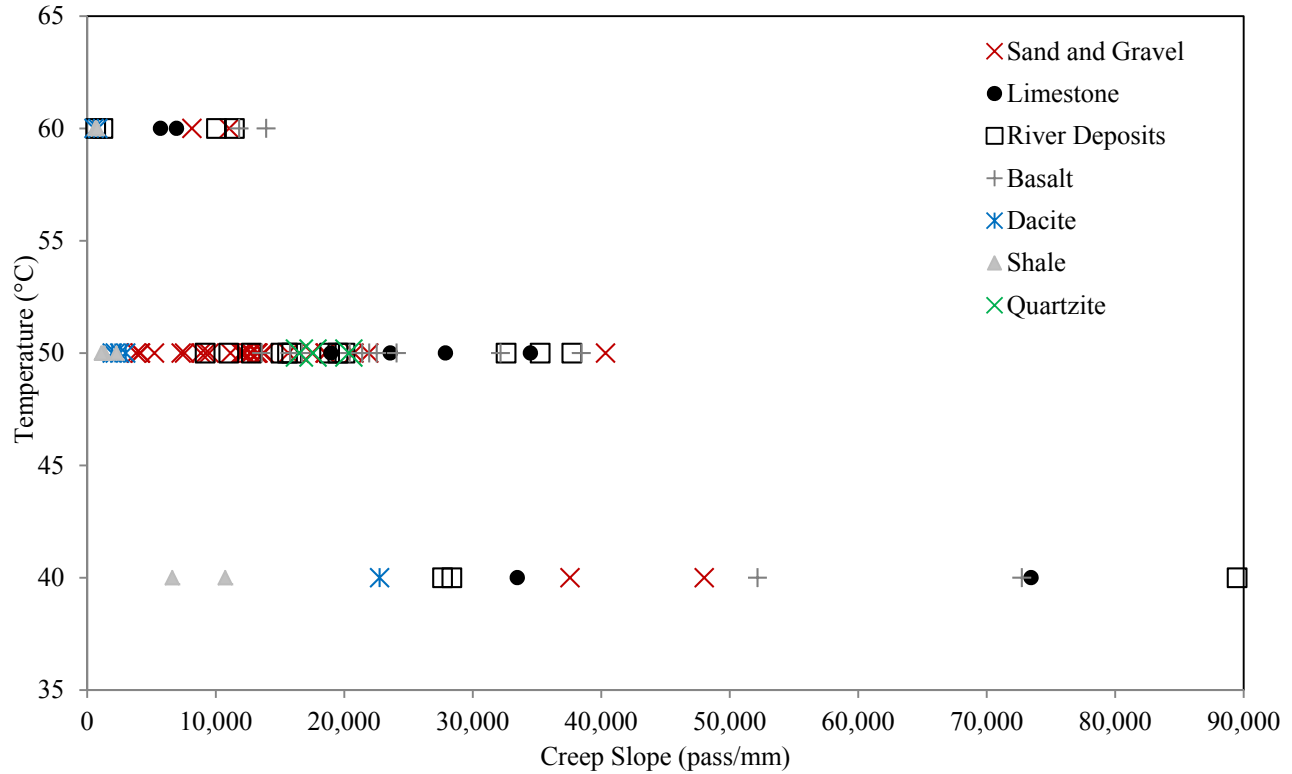

Figure 4.18 Type of Aggregate Creep Slope due temperature test

Shale and dacite showed the lower performance in the creeping phase for the three test temperatures. A significant diminution in the creep slope was observed for these aggregates when the temperature increased. River deposits and limestone show discrepancy in creep slopes at 40 °C. Anyhow, average and high creep slopes were observed in both cases. Sand and gravel, and basalt show consistent results with average results at 40 °C.

Besides dacite and shale, aggregates tested at 50 °C showed consistent and better results for limestone. Sand and gravel had a high variation in creep slopes at this temperature. Mostly, creep slopes oscillate from 3,000 to 22,000 passes/mm. Similarly, river deposits show high discrepancy in creep slopes. Quartzite showed consistent creep slopes in the average gap of aggregates tested

at 50 °C. In addition, basalt and limestone showed gaps in creep slopes. Anyhow, better results were observed for these two aggregates. From previous figure, it can be observed that increasing the temperature from 50 to 60 °C is reducing the creep slopes for all of the tested aggregates. Anyhow, better performance was observed for basalt. River deposits, sand and gravel, and limestone performed similar.

For stripping phase, Figure 4.19 depicts the effect of temperature in the type of aggregate for mixtures with stripping.

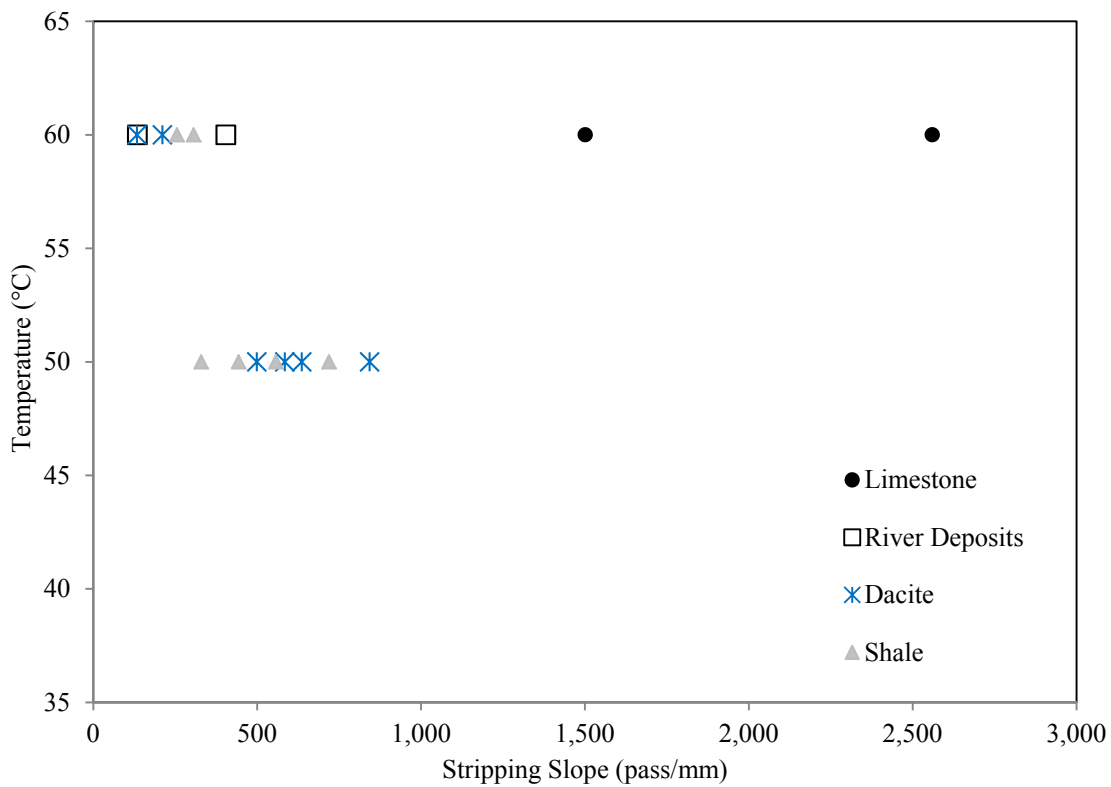
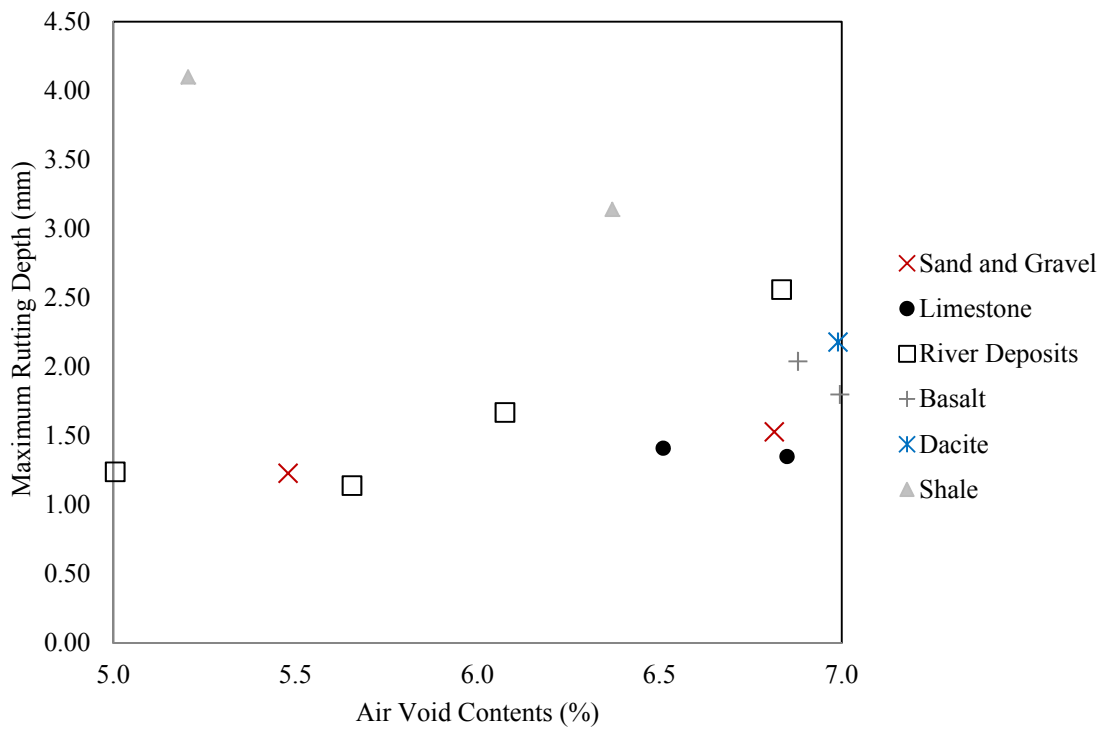

Figure 4.19 Type of Aggregate Stripping Slope due Temperature Test

It can be noticed from previous figure that only four of the seven mixtures reached this HWTD phase. Quartzite, sand and gravel, and basalt only reached the creep phase. It can be observed that none of the seven mixtures reached stripping at 40 °C. At 50 °C, dacite and shale showed stripping. Anyhow, dacite showed fairly better results. At 60 °C, four mixtures reached the

mentioned phase (limestone, dacite, shale and river deposits). In this case, dacite showed better results than shale. River deposits showed the lowest stripping slope in one of the tests at this temperature. A second test reached stripping for river deposits overpassing shale and dacite stripping slopes. Finally, limestone reached stripping at 60 °C with significant better results compared to the other three aggregates.

As defined in the objectives of this section, the effect of AV must be considered in order to understand the effect of this parameter in AC mixtures when tested in HWTD. Figure 4.19 depicts the maximum rutting depth for each type of aggregate according the AV contents for the defined test temperatures.



(a)

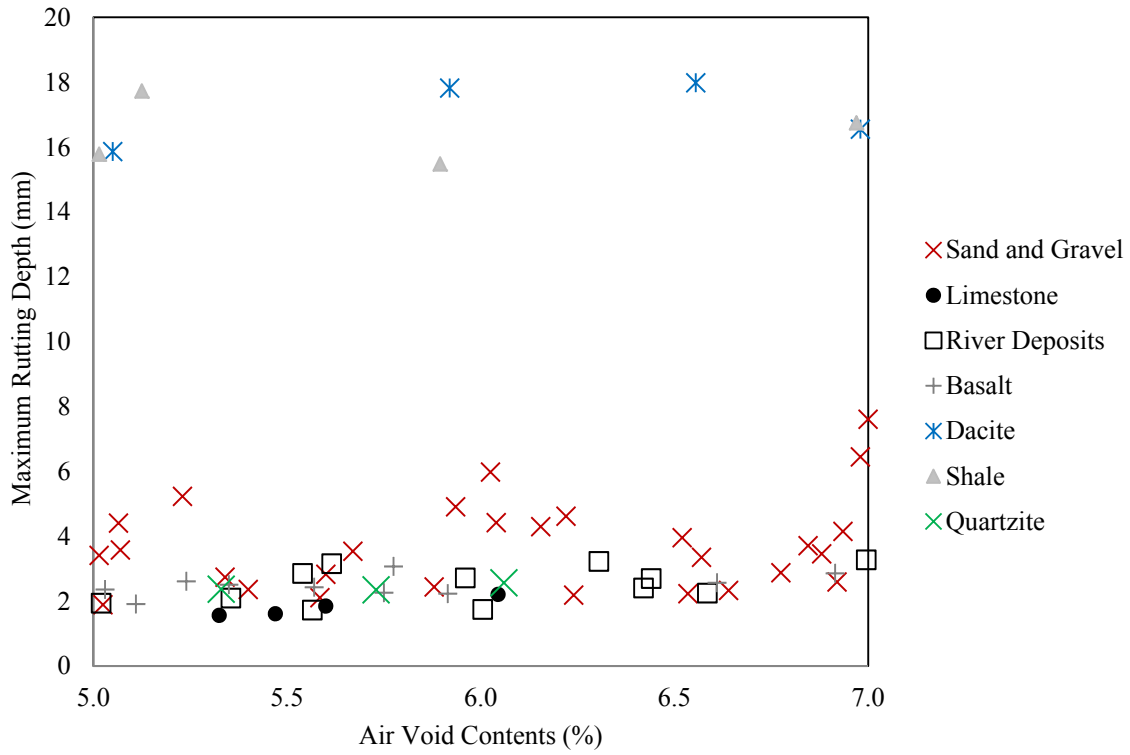

(b)

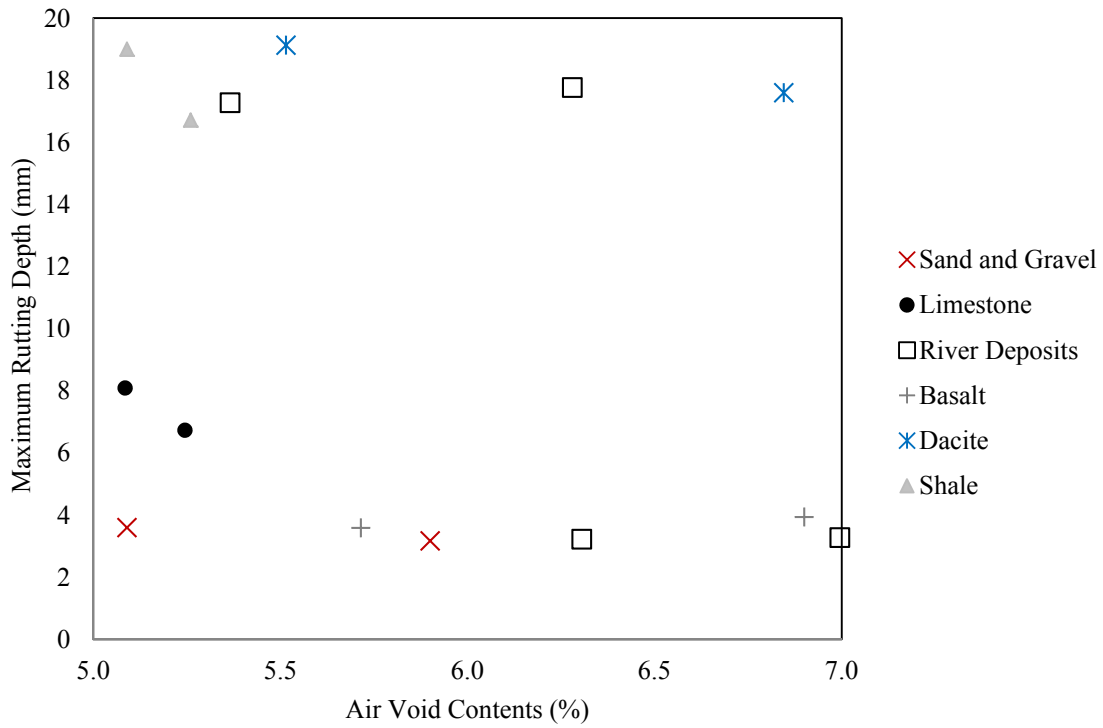

(c)

Figure 4.20 Type of Aggregate Maximum Rutting Depth According to AV contents (a) 40 °C (b) 50 °C (c) 60 °C

From Figure 4.20 (a), no relationship between AV contents and aggregate can be observed since maximum rutting depth results changes with increasing or decreasing of the AV contents for aggregates tested at 40 °C. Similarly, when aggregates were tested at 50 °C no relationship was observed between AV contents and aggregates as shown in Figure 4.20 (b). Finally when WHTD was performed at 60 °C, river deposits showed better results in R2 and R3. Anyhow, no correlation was observed for other aggregates.

Comparing mixture 4 and 6 when only type of aggregate differs, it can be observed that basalt performs better than shale. Similar AC mixture properties can be observed in mixture 18 and 20. In this case, a quartzite and river deposits aggregate varies as type of aggregate with better performance for the last aggregate. Similarly, river deposits showed better rutting behavior than sand and gravel aggregate when mixture 5 was compared with mixtures 1, 9, 10, 11 and 13. Comparing mixture 2 and mixture 17, limestone showed better results than basalt aggregate. This finding leads to assume that limestone behaves better than shale in HWTD assuming that type of mixture, type of binder PG and type of gradation are similar. In general, limestone showed to be the best aggregate from the seven studied type of aggregates.

4.5 TYPE OF BINDER PERFORMANCE GRADE

As discussed, five type of binder were used in order to test HMA/WMA mixtures in HWTD. Figure 4.21 depicts the maximum rutting depth for each of the defined binders for the different set temperatures.

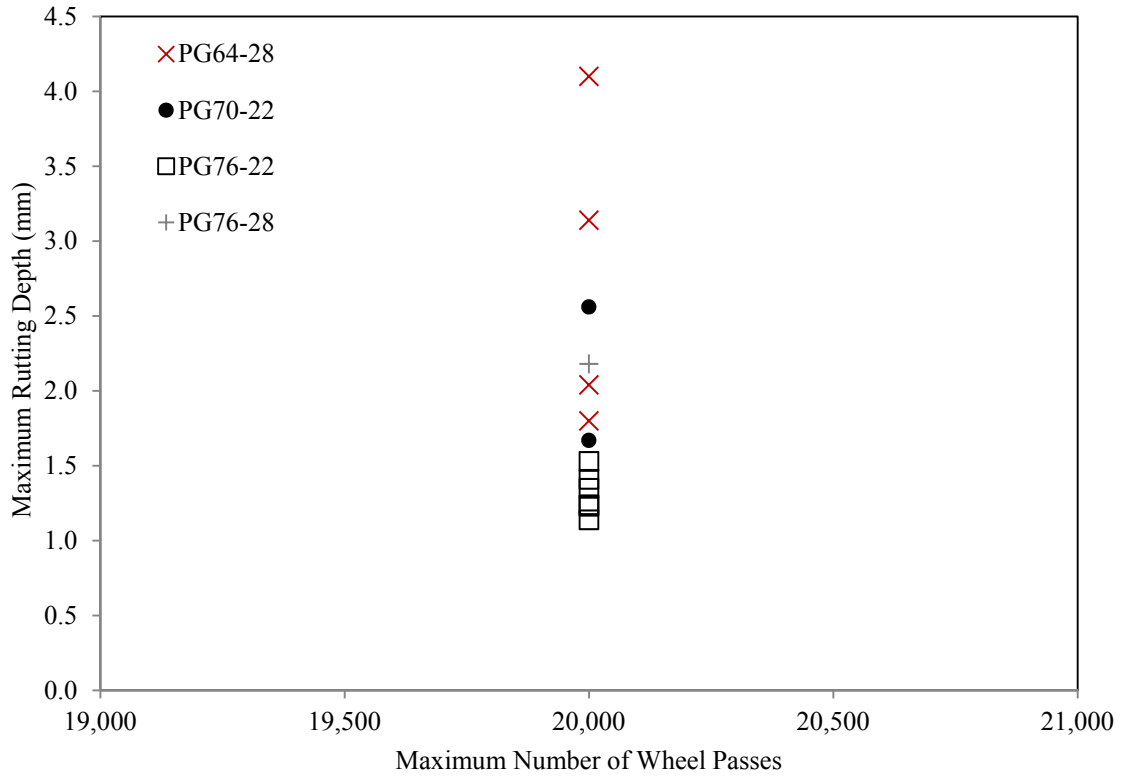

(a)

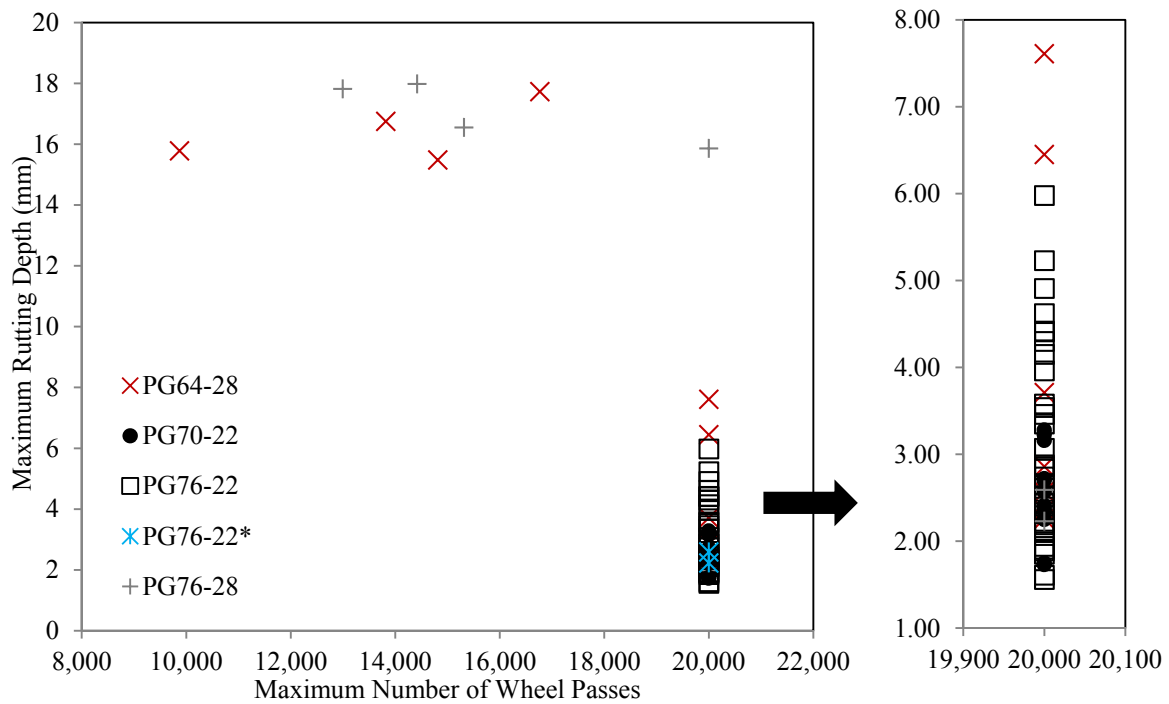

(b)

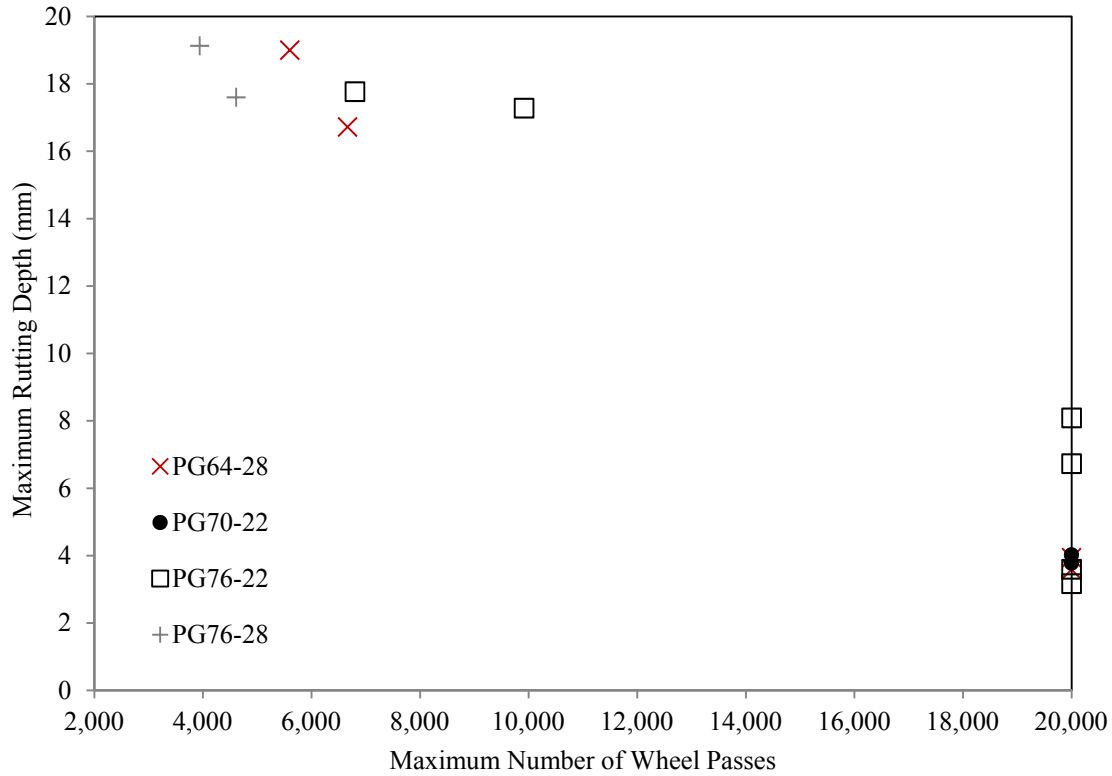

(c)
Figure 4.21 Type of Binder Performance Grade Maximum Impression Vs Maximum Wheel Passes at (a) 40 °C (b) 50 °C (c) 60 °C

From previous figure, low rutting depths were observed for PG76-22 at 40 °C along with the best performance. PG64-28 showed variation in the results with the highest rutting depth of all binder grades at this temperature in two tests. PG70-22 showed results in the middle range as PG76-28. For 50 °C, two of the five binder PG's failed (PG76-28 and PG64-28). Anyhow, PG64-28 showed results in the passing criteria differently from PG76-28 that failed in all the tests performed at this temperature. Comparing PG70-22 and PG76-22 at 50 °C, PG70-22 showed consistent and better results at this temperature. For PG70-22 and the modified polymer, results were located in the average region of results without the modified polymer. Anyhow, PG76-22 showed high variability with results oscillating from 1.5 (lowest) to 6 mm. in the passing criteria.

For binders tested at 60 °C, three binder grades failed (PG64-28, PG76-22 and PG76-28). However, PG64-28 and PG76-22 showed results in the passing criteria with better performance for PG64-28. From all binders tested, PG70-22 showed consistency and better results at this temperature.

Figure 4.22 depicts the post-compaction slope for each of the binders tested at different temperatures.

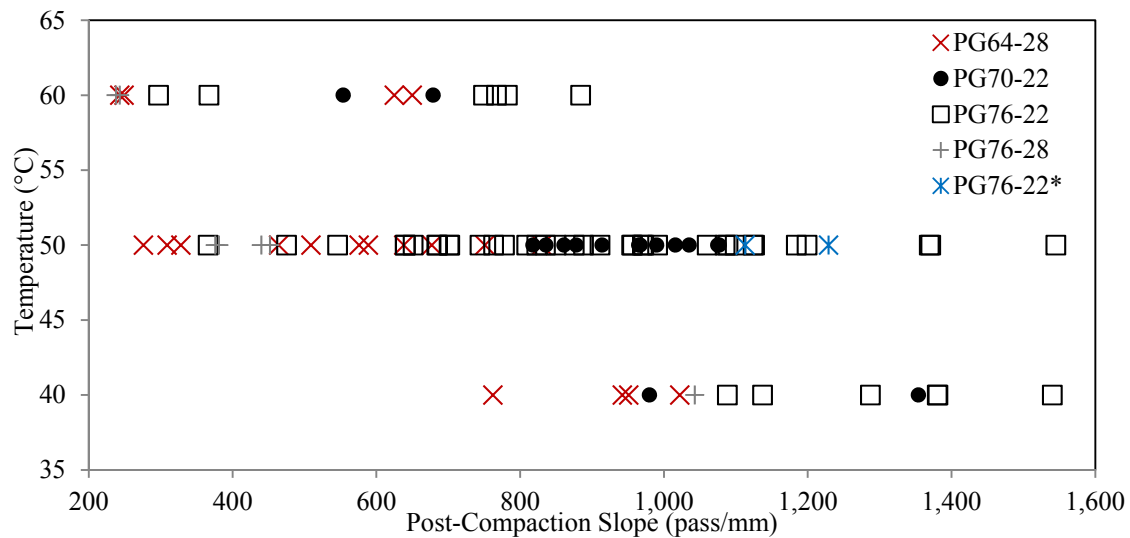

Figure 4.22 Type of Binder PG Post-Compaction Slope due Temperature Test

For 40 °C, better results were observed for PG76-22. Differently, PG64-28 showed the lowest post-compaction slopes. No consistent results were observed for PG70-22. However, better results than PG64-28 were observed as well as PG76-28. For 50 °C, a similar trend in post-compaction slopes was observed. PG64-28 showed the lowest results along with PG76-28. The increase of temperature reduced significantly the resistance of PG76-28 in the HWT phase. Variability in results was observed for PG76-22 with the highest-compaction slopes and results close to the lowest. For PG70-22, no discrepancy in post-compaction slopes was observed with results in the average region. PG76-22 with the modified polymer showed good results either.

For 60 °C, all binder grades are being affected when the temperature increased. Generally, better performance was observed for PG76-22.

Figure 4.23 depicts the creep slope for each of the binders tested at different temperatures.

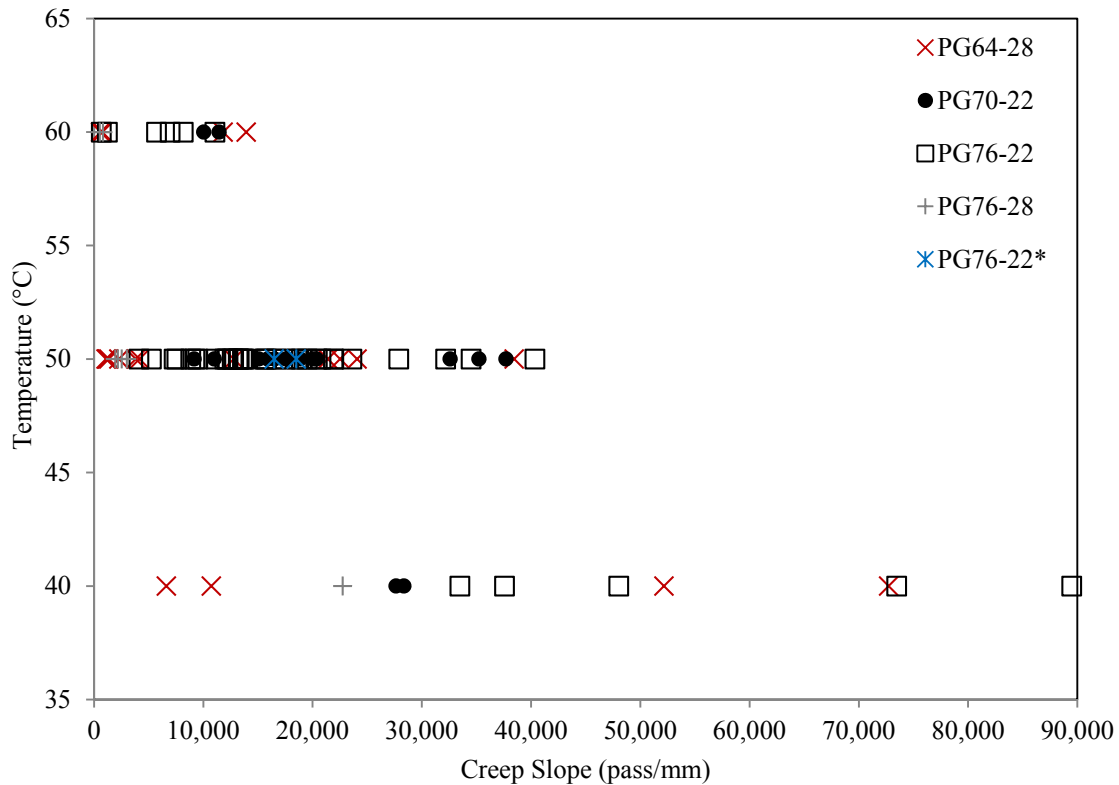

Figure 4.23 Type of Binder PG Creep Slope due temperature test

For the creeping phase, better results were observed for PG76-22 at 40 °C. PG64-28 showed two regions (low and high) of performance at 40 °C. PG70-22 and PG76-28 performed similarly with creep slopes oscillating from 20,000 to 30,000 passes/mm. PG76-28 creep slopes were significantly diminished when temperature increased. In addition, PG76-22 and PG64-28 showed decrease in the creep slopes at 50 °C. A decrease and increase of creep slopes was observed for PG70-22. Anyhow, PG76-22 and PG70-22 showed better results at this temperature. A significant decrease of creep slopes was observed for all type of binders at 60 °C. PG70-22 showed better performance at this temperature. Differently, the other three binder grades showed

creep slopes below the 5,000 passes/mm. However, PG64-28 and PG76-22 showed similar results as PG70-22 in some tests.

Figure 4.24 depicts the stripping slopes for each of the binders tested at different temperatures.

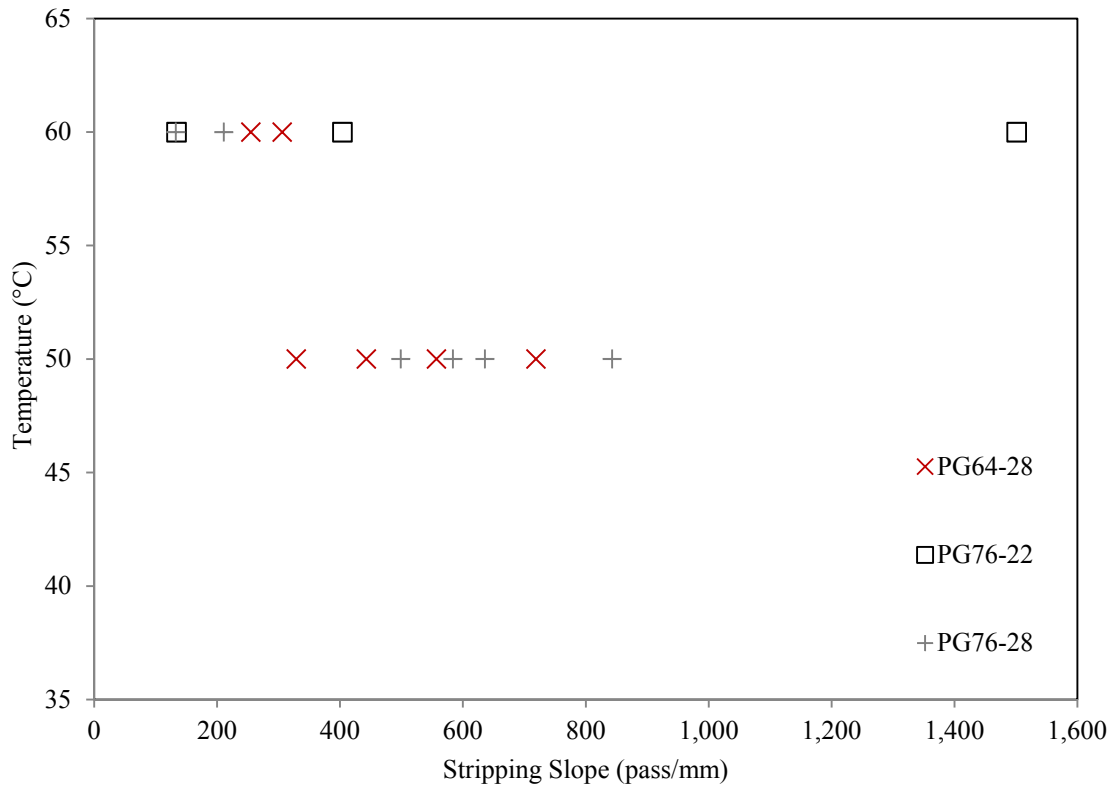
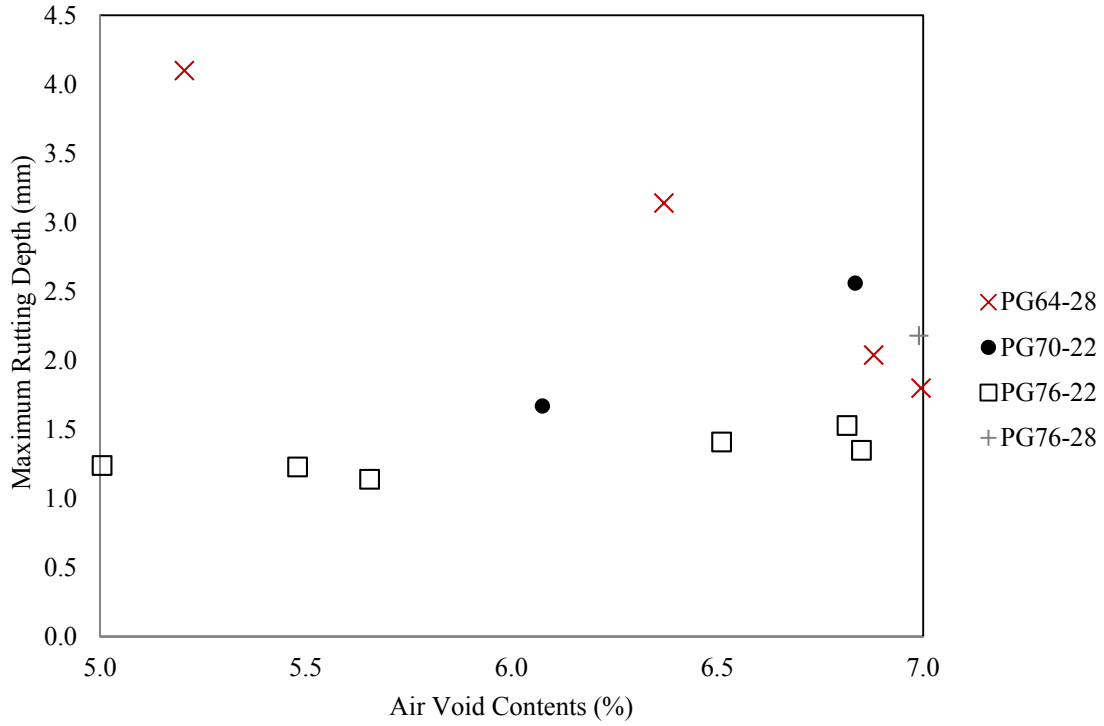

Figure 4.24 Type of Binder PG Stripping Slope due temperature test

None of the binders showed stripping at 40 °C. PG70-22 did not show stripping at any of the test temperatures. For 50 °C, PG76-28 showed better results than PG64-28. Differently, PG76-22 did not show stripping at this temperature. At 60 °C, PG76-28 showed a significant decrease in the stripping results. Differently, PG64-28 showed better results than PG76-28. PG76-22 showed high discrepancy in results at this temperature.

Figure 4.25 depicts the maximum rutting depth for each type of binder performance grades according the AV contents for the defined test temperatures.



(a)

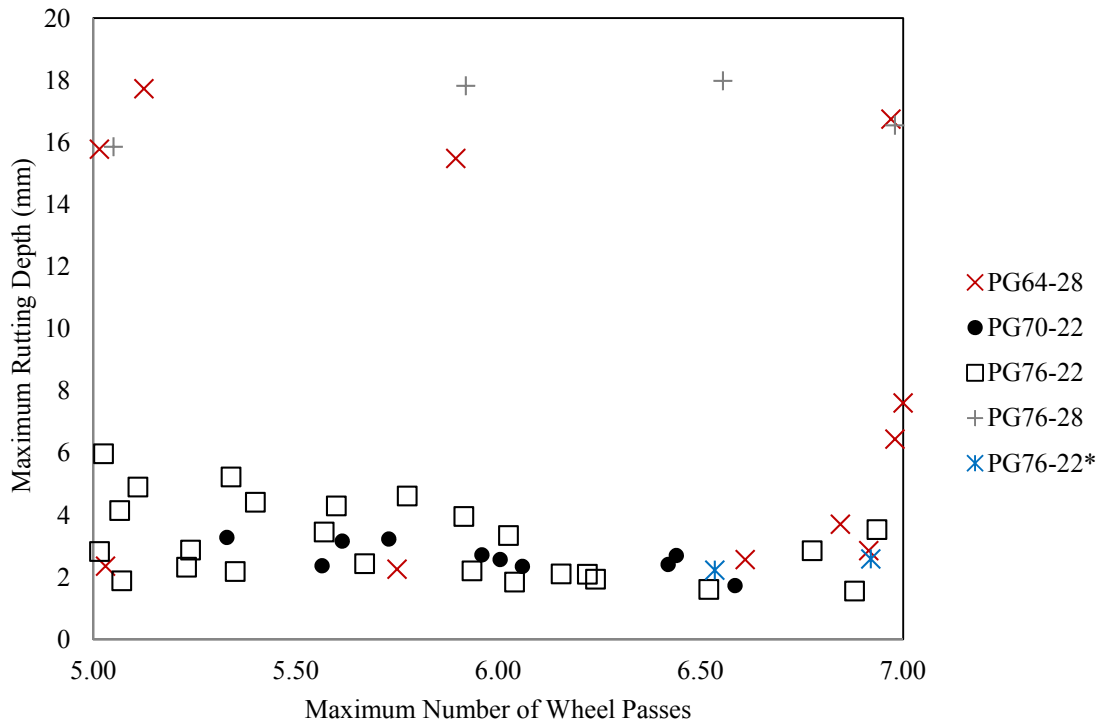

(b)

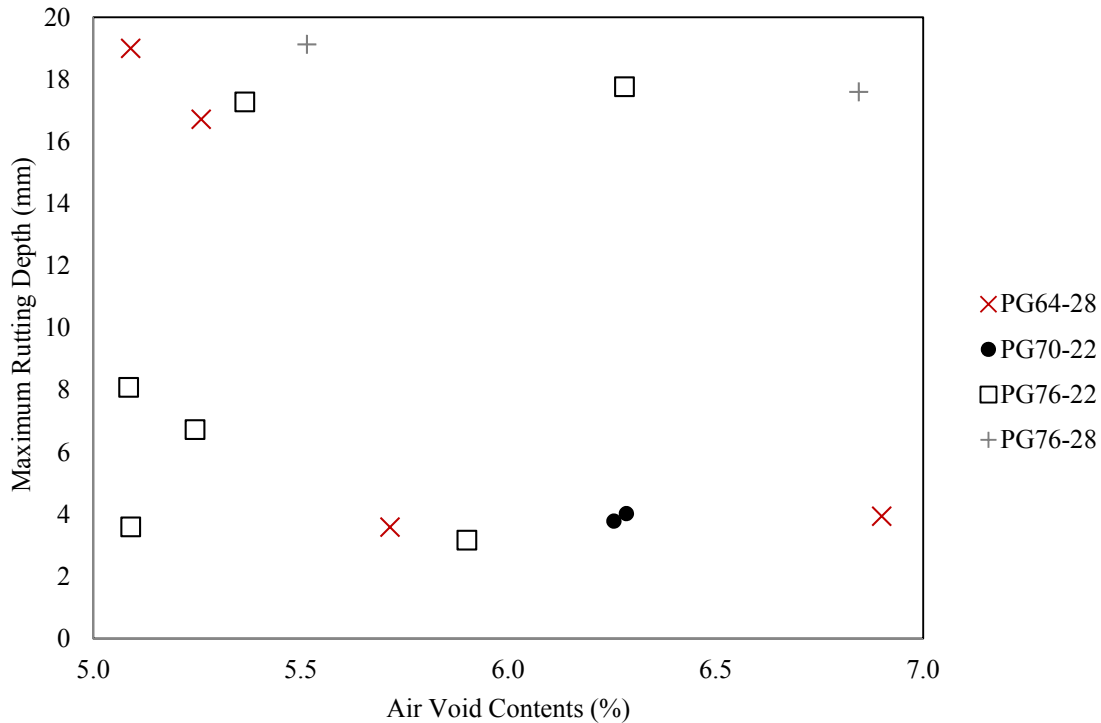

(c)

**Figure 4.25 Type of Binder PG Maximum Rutting Depth According to AV contents
(a) 40 °C (b) 50 °C (c) 60 °C**

From previous figure, PG76-22 did not show a significant variation of maximum rutting depths related to the change of AV contents at 40 °C. For PG64-28, better results were observed in R3 at 40 °C. Due test numbers performed for PG70-22 and PG76-28 at 40 °C, no relationship was observed. At 50 °C, no correlation was observed for any of the tested binder due the variation of AV contents. Anyhow, R2 showed more consistency in the results with the lowest maximum rutting depths. Similarly, type of binder tested at 60 °C did not show any correlation between AV contents and maximum rutting depth.

Chapter 5 WEIBULL MODEL

5.1 GENERAL

This chapter is dedicated to present a model using the Weibull function in order to predict rutting behavior of AC mixtures expressed in the HWTD results

Specific objectives of this chapter are:

- Define the Weibull parameters (β and η) for each tested mixture under rutting distresses
- Generalized parameters for the studied parameters in chapter 4 related to test temperature
- Observe the correlation between the model and tested mixtures

As defined in chapter 2, the Weibull function is given in Equation 1. For this study, the following equation is modified in order to predict rutting at different number of wheel passes.

$$RD(N) = \frac{\beta}{\eta} \left[\frac{N-\gamma}{\eta} \right]^{\beta-1} \quad (8)$$

where

$RD(N)$ = Rutting depth at different number of wheel passes in mm.

β = shape parameter

η = scale parameter

Weibull parameters are defined in Table 5.1. The following table describes the shape and scale parameters obtained for AC mixtures tested at different temperatures for rutting distresses only.

As studied before, mixtures failed due the type of mixture, aggregate, gradation and binder grade. Mixtures with stripping at 50 °C were not considered for this study.

Table 5.1 AC Mixtures Weibull Parameters

Mixture	Temperature	β	η
1	50	1.3178	7.0359
		1.2873	4.2237
	50	1.2929	6.3637
		1.3032	6.7249
	40	1.1796	4.3492
		1.2052	4.7532
	60	1.4013	8.9178
		1.3010	5.0730
2	40	1.1630	3.1733
		1.2289	5.7209
	50	1.2160	4.2004
		1.2072	3.3127
	50	1.2310	5.5853
		1.2914	8.0138
3	50	1.2989	5.0513
		1.2789	4.9485
	50	1.3374	7.1989
		1.2048	3.0294
	40	1.3053	8.4536
		1.3188	6.4156
	60	1.2661	3.3461
		1.3253	5.3255
	50	1.3798	8.4486
		1.3608	7.9689
4	50	1.2225	3.4699
		1.1426	1.8897

Mixture	Temperature	β	η
	60	1.2617	3.5150
		1.2746	3.4063
	50	1.2144	3.1009
		1.1875	2.2745
	40	1.1721	2.4799
		1.1668	2.7294
5	50	1.2966	7.3186
	50	1.3856	11.6167
		1.3341	7.1522
	40	1.1304	2.8485
		1.1728	4.4694
8	50	1.3226	5.2715
		1.4899	11.2612
9	50	1.3361	5.1207
		1.4219	8.1749
10	50	1.2730	3.1677
		1.2586	2.7872
11	50	1.3187	5.3423
		1.4558	11.1571
12	50	1.3364	8.6085
		1.3521	8.4476
13	50	1.2126	3.5035
		1.1700	1.3208
	50	1.3089	5.6471
		1.3906	7.7699
14	50	1.2793	6.6689

Mixture	Temperature	β	η
		1.3092	6.0365
		1.2980	5.9607
	50	1.3303	8.1817
15	50	1.2202	4.1393
	50	1.2431	4.1363
	50	1.2743	5.4160
16	50	1.2730	3.6025
	50	1.4297	7.6948
	50	1.4864	8.8142
17	50	1.2739	5.3095
	50	1.2586	3.7747
	50	1.3280	7.3945
18	50	1.2749	5.2060
	50	1.3068	6.6687
	50	1.3053	6.1450
19	50	1.3439	5.2954
	50	1.3263	5.4447
	50	1.3119	5.3857
20	50	1.1715	3.0752
	50	1.2305	4.9015
	50	1.2634	5.2361

5.2 TYPE OF MIXTURE WEIBULL PARAMETERS

Figure 5.1 depicts the generalized line for shape and scale parameters for WMA mixtures at different test temperatures.

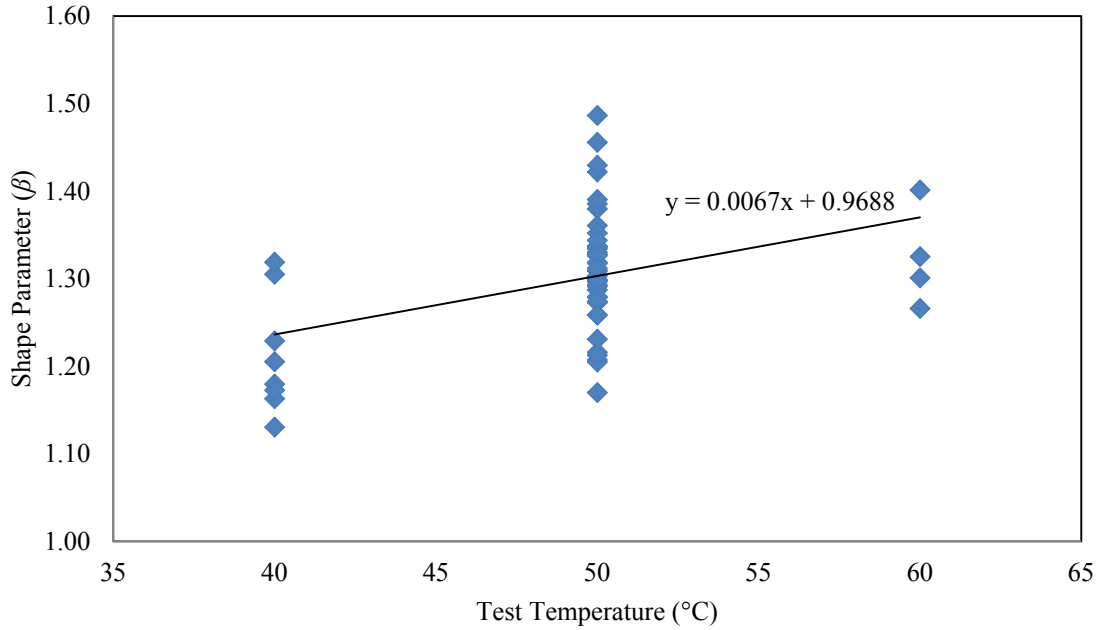

(a)

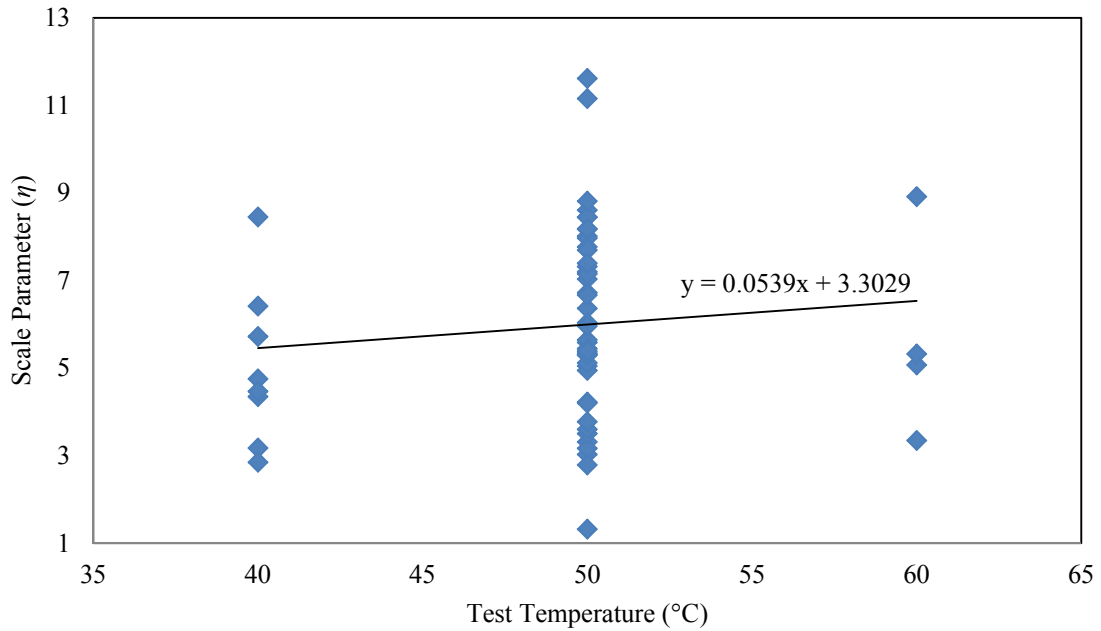

(b)

Figure 5.1 Shape and Scale parameters for WMA mixtures

Figure 5.2 depicts the generalized line for shape and scale parameters for HMA mixtures at different test temperatures.

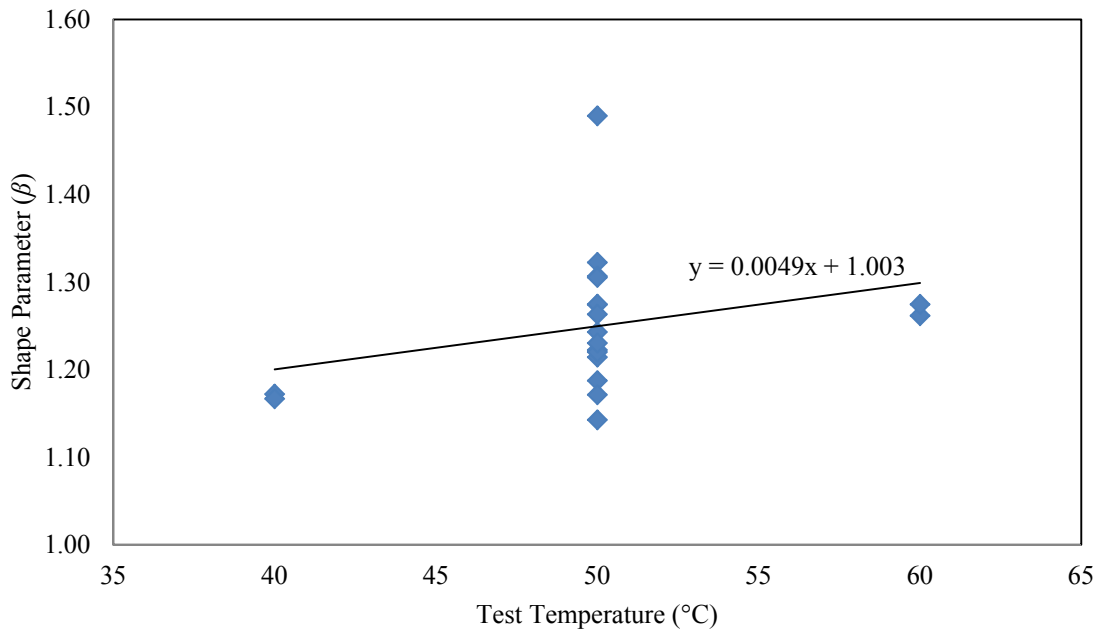

(a)

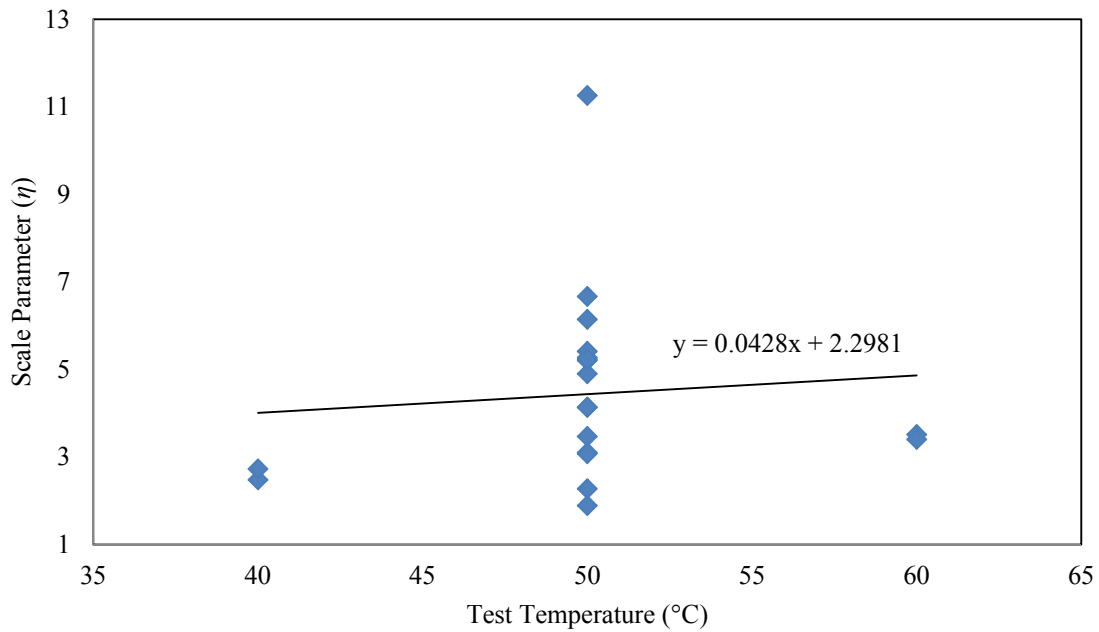

(b)

Figure 5.2 Shape and Scale parameters for HMA mixtures

5.3 TYPE OF GRADATION WEIBULL PARAMETERS

Figure 5.3 depicts the generalized line for shape and scale parameters for finer gradation mixtures at different test temperatures.

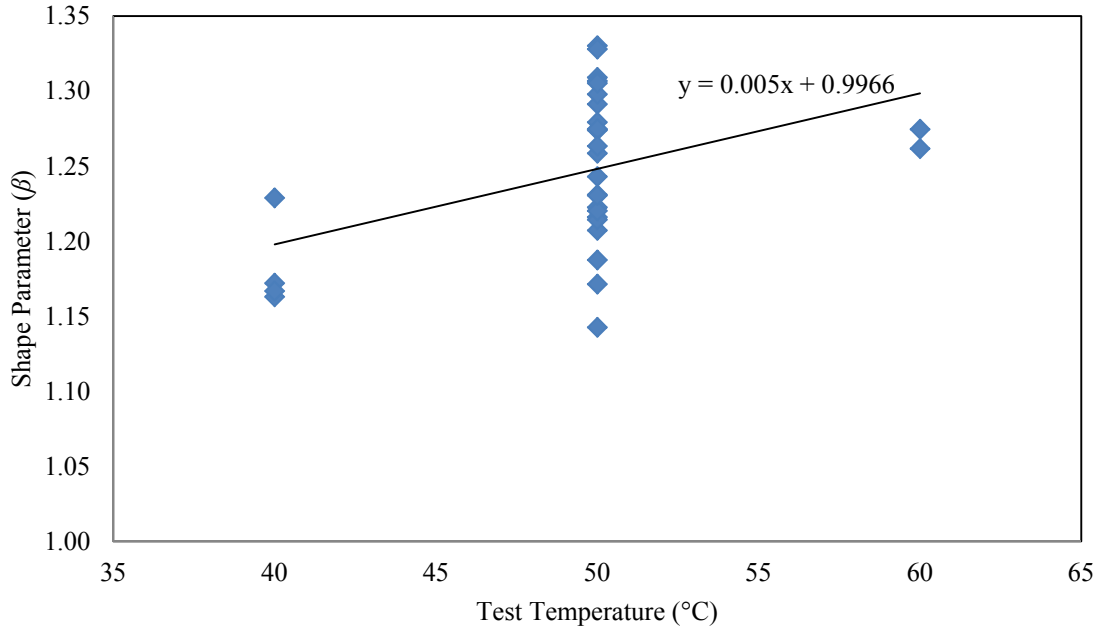

(a)

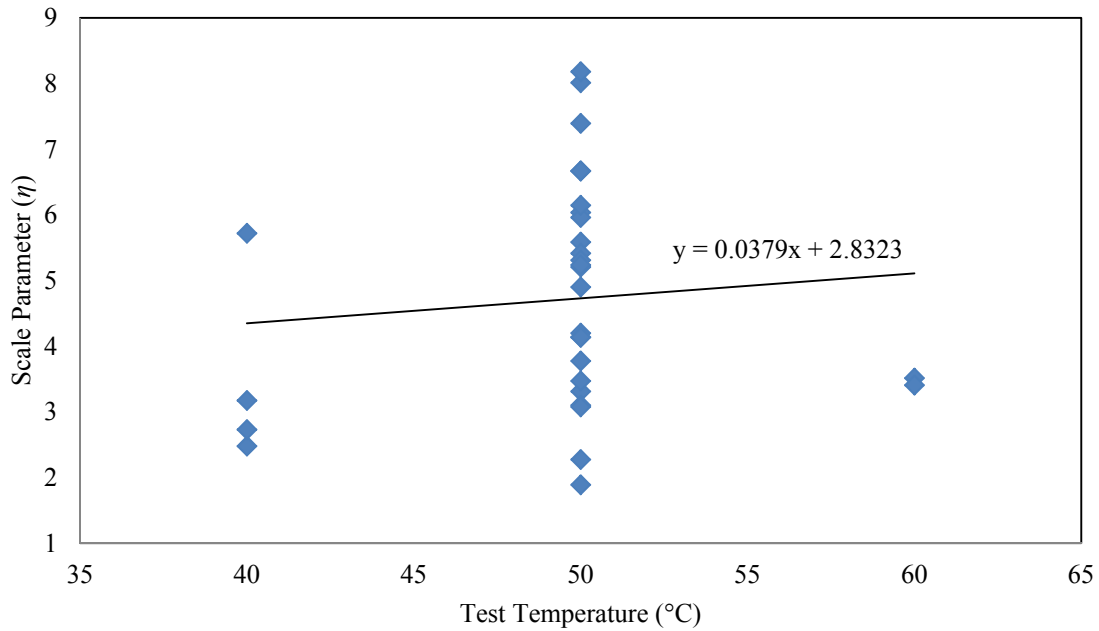

(b)

Figure 5.3 Shape and Scale parameters for finer mixtures

Figure 5.4 depicts the generalized line for shape and scale parameters for coarser gradation mixtures at different test temperatures.

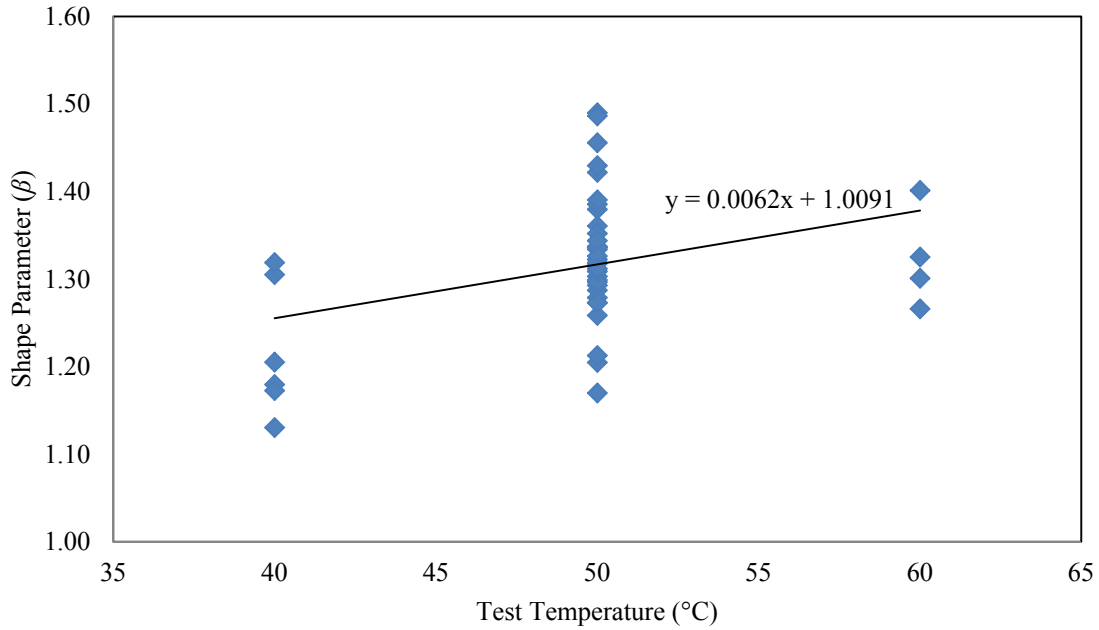

(a)

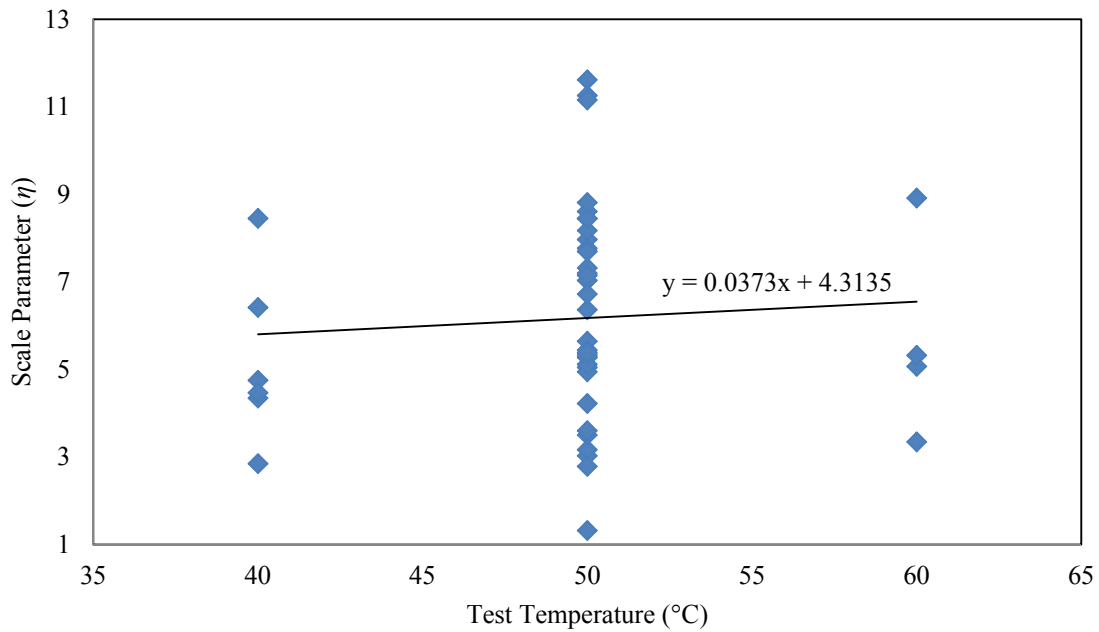

(b)

Figure 5.4 Shape and Scale parameters for coarser mixtures

5.4 TYPE OF AGGREGATE WEIBULL PARAMETERS

As described, only 5 types of aggregates were considered for this analysis (Basalt, limestone, sand and gravel, river deposits and quartzite). Dacite and shale were discarded due the high tendency to reach stripping at the standard test temperature. Quartzite was tested only at 50 °C temperature. Shape and scale parameter were defined only for that temperature expressed in Table 5.2.

Table 5.2 Shape and Scale Parameters for Quartzite Aggregate

β	η
1.2957	6.0065

Figure 5.5 depicts the generalized line for shape and scale parameters for basalt aggregate mixtures at different test temperatures.

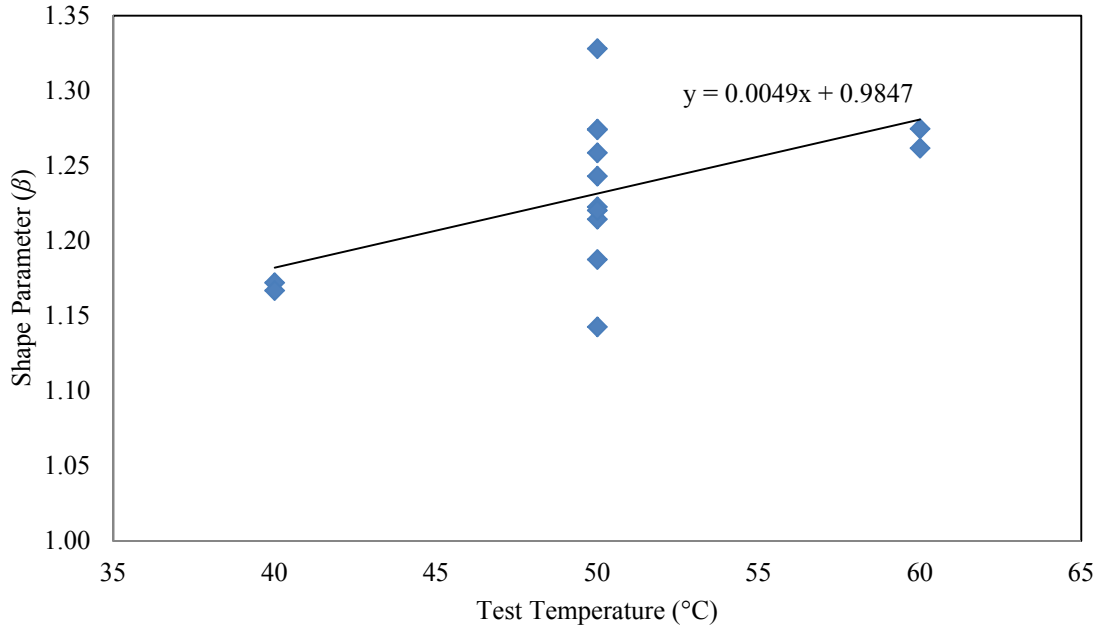

(a)

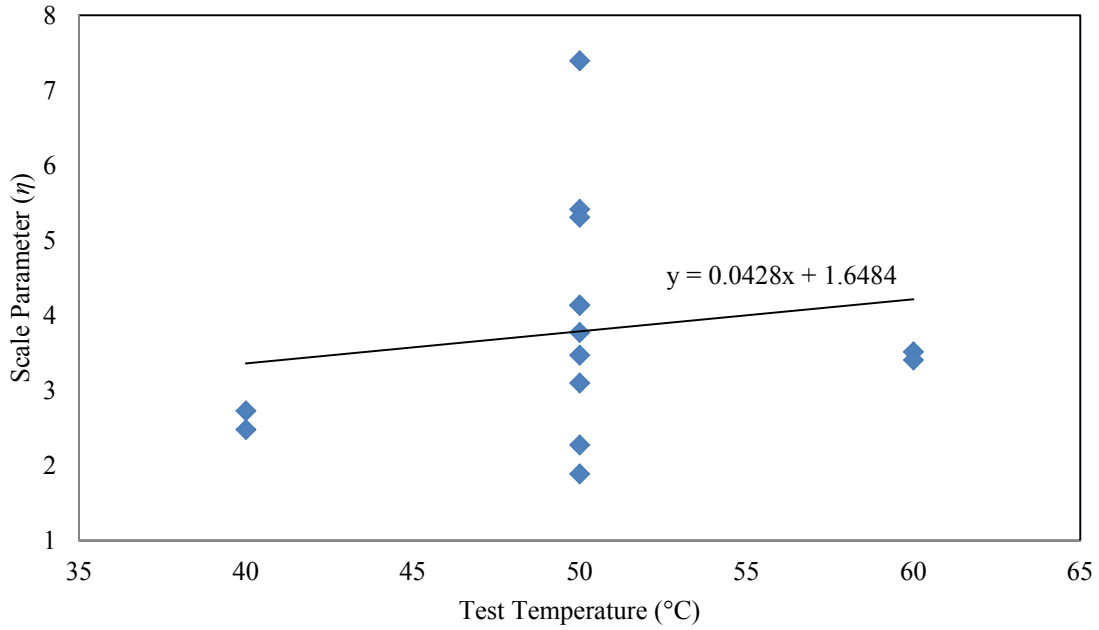

(b)

Figure 5.5 Shape and Scale parameters for basalt aggregate

Figure 5.6 depicts the generalized line for shape and scale parameters for limestone aggregate mixtures at different test temperatures.

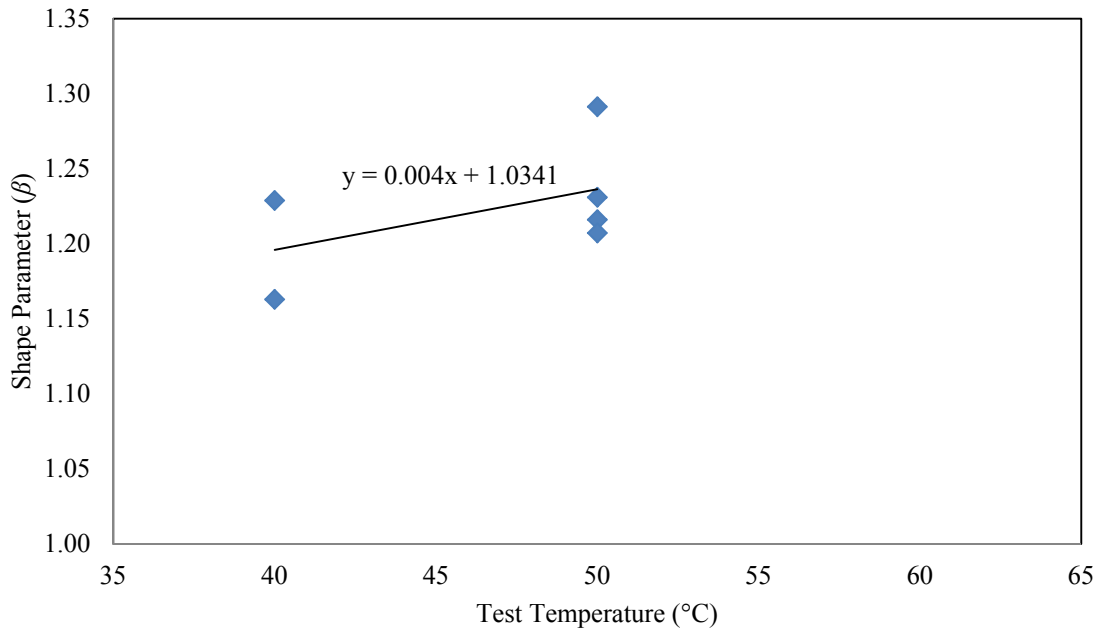

(a)

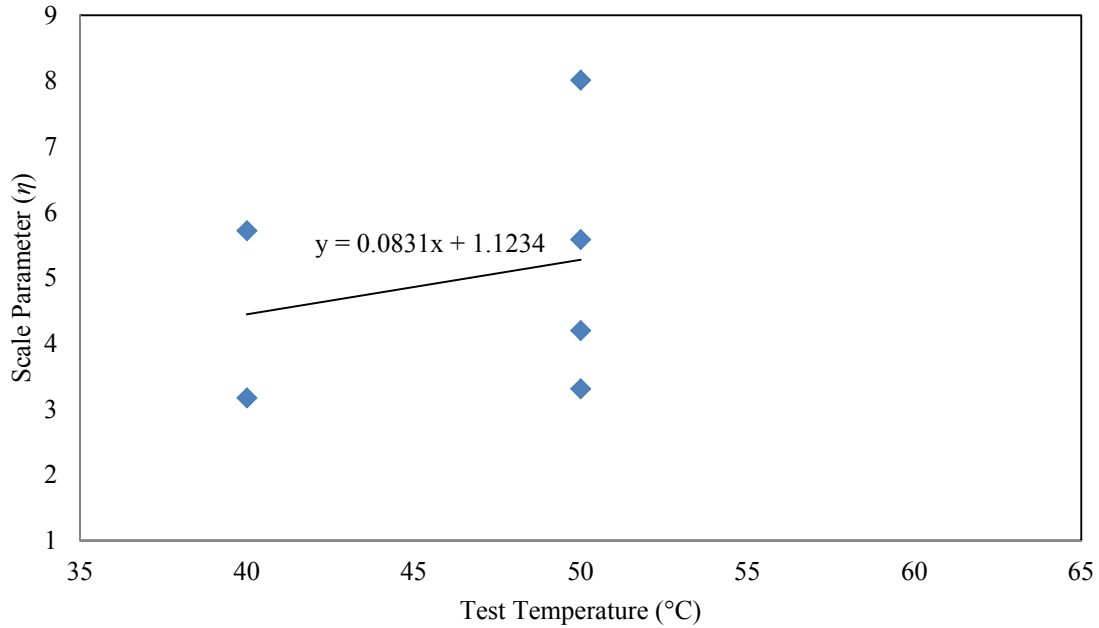

(b)

Figure 5.6 Shape and Scale parameters for limestone aggregate

Figure 5.7 depicts the generalized line for shape and scale parameters for sand and gravel aggregate mixtures at different test temperatures.

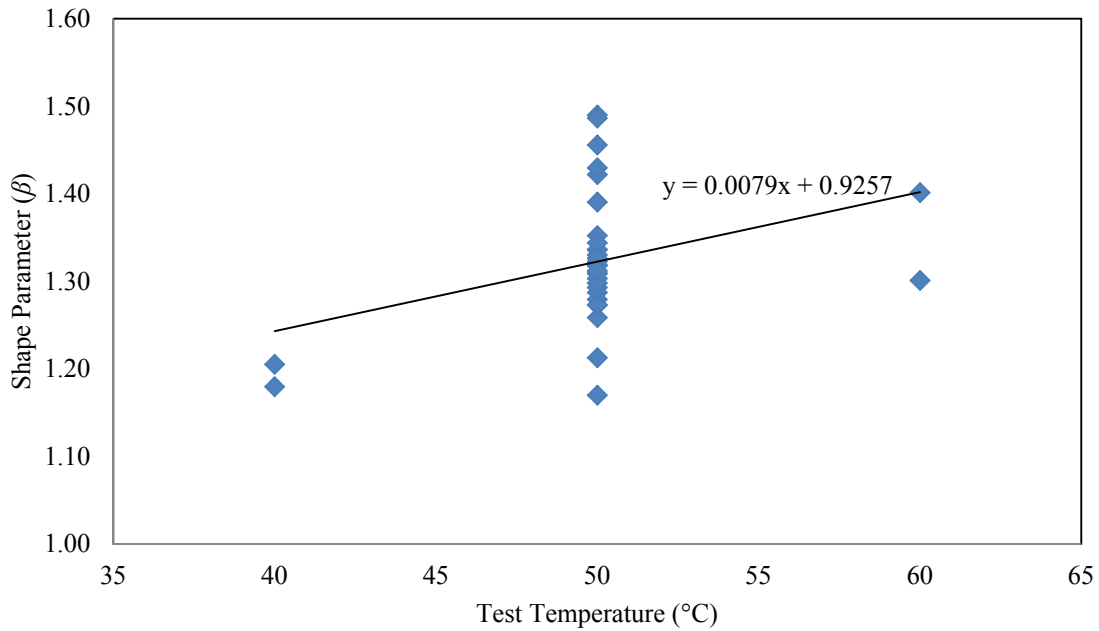

(a)

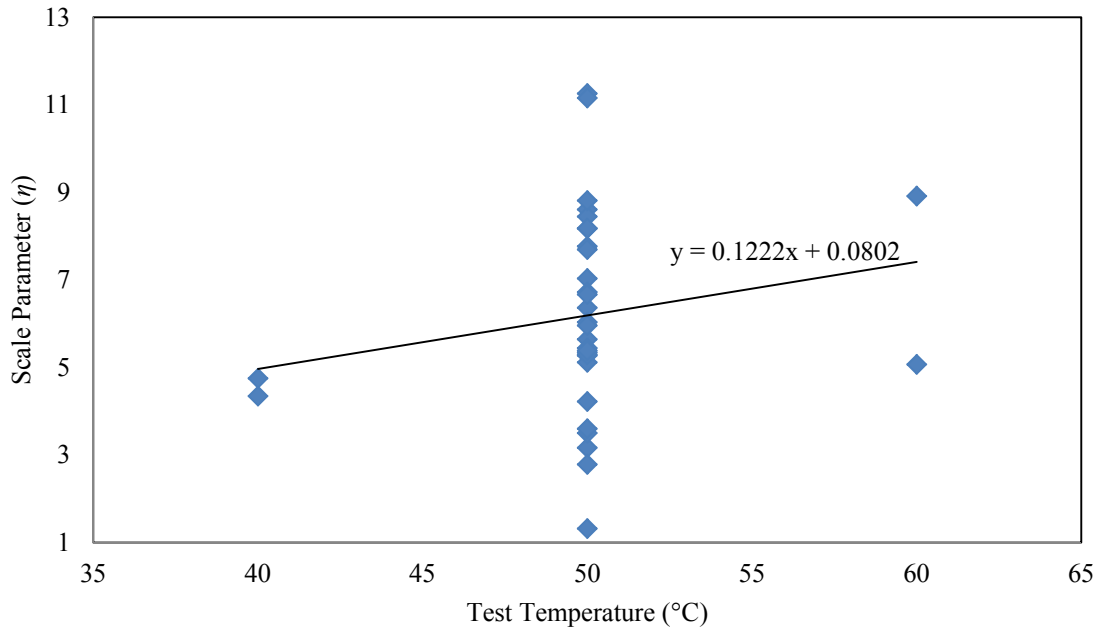

(b)

Figure 5.7 Shape and Scale parameters for sand and gravel aggregate

Figure 5.8 depicts the generalized line for shape and scale parameters for river deposits aggregate mixtures at different test temperatures.

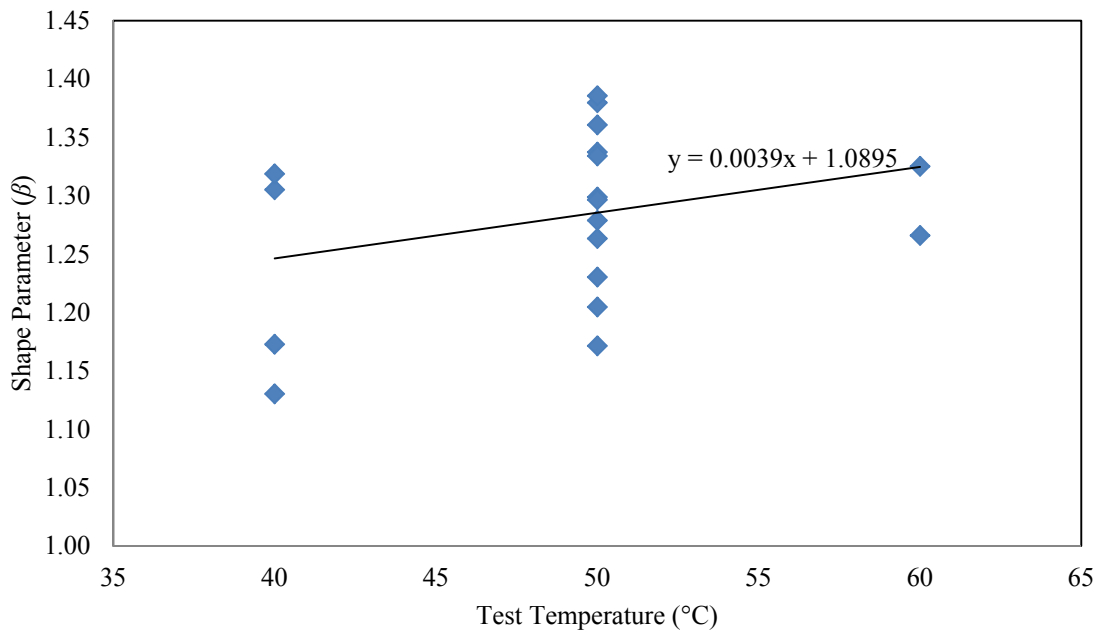

(a)

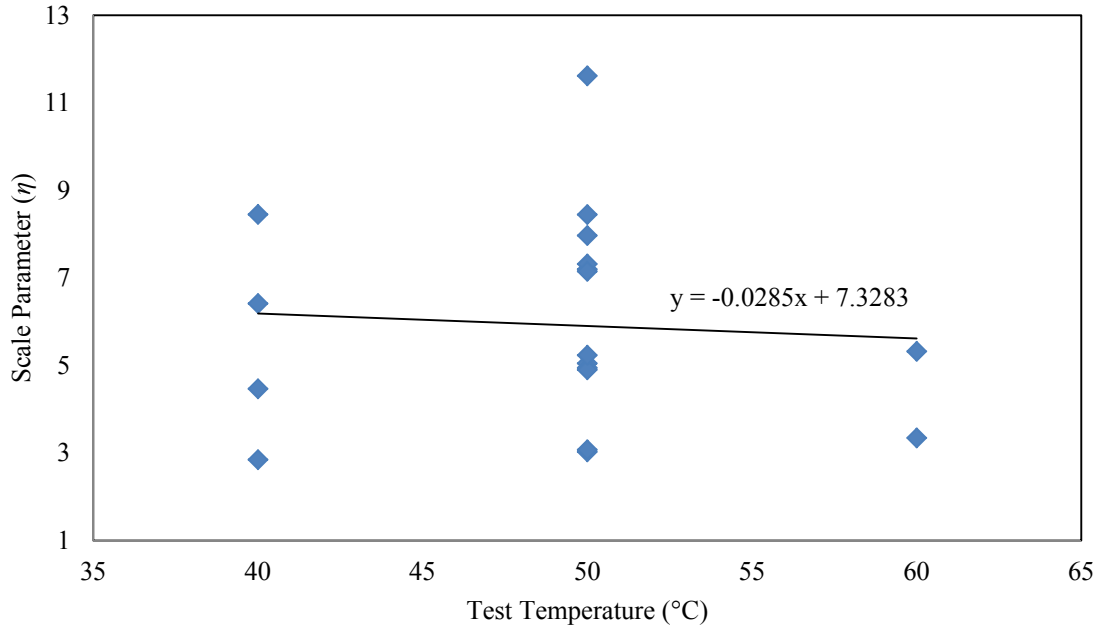

(b)

Figure 5.8 Shape and Scale parameters for river deposits aggregate

5.5 TYPE OF BINDER PERFORMANCE GRADE WEIBULL PARAMETERS

As described, only 3 types of binder PG were considered for this analysis (PG64-28, PG70-22 and PG76-22). PG76-28 was discarded due the high tendency to reach stripping at the standard test temperature in HWTD results. As defined, one mixture in the PG76-22 group was in presence of a modified polymer. The following table summarizes the Weibull parameters for that mixture.

Table 5.3 Shape and Scale Parameters for PG76-22 and Modified Polymer

β	η
1.3442	8.5281

Figure 5.9 depicts the generalized line for shape and scale parameters for PG64-28 mixtures at different test temperatures.

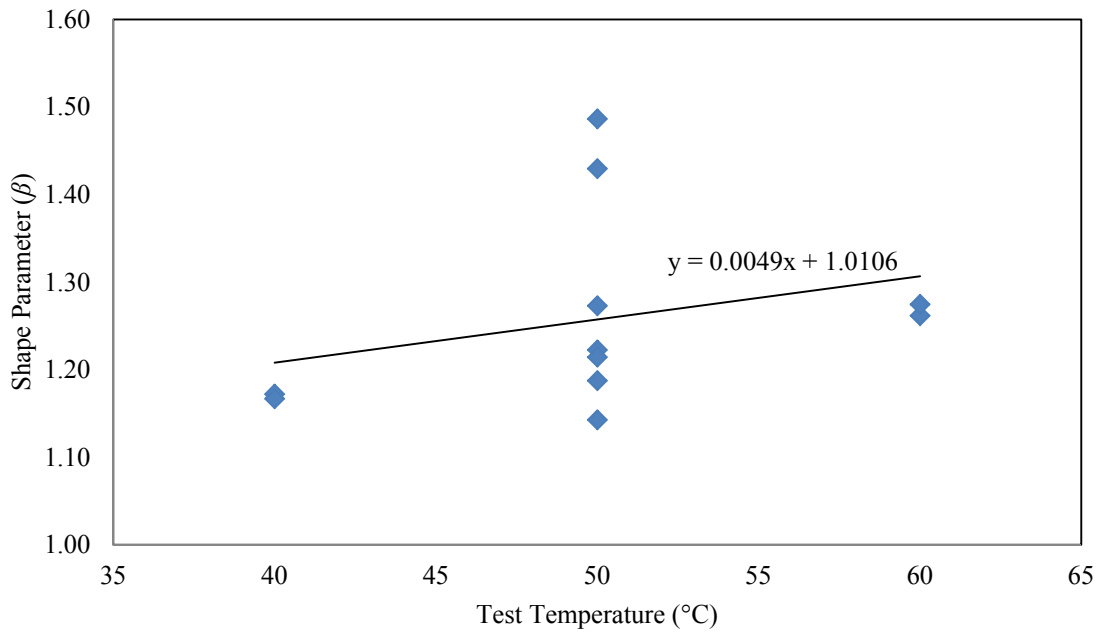

(a)

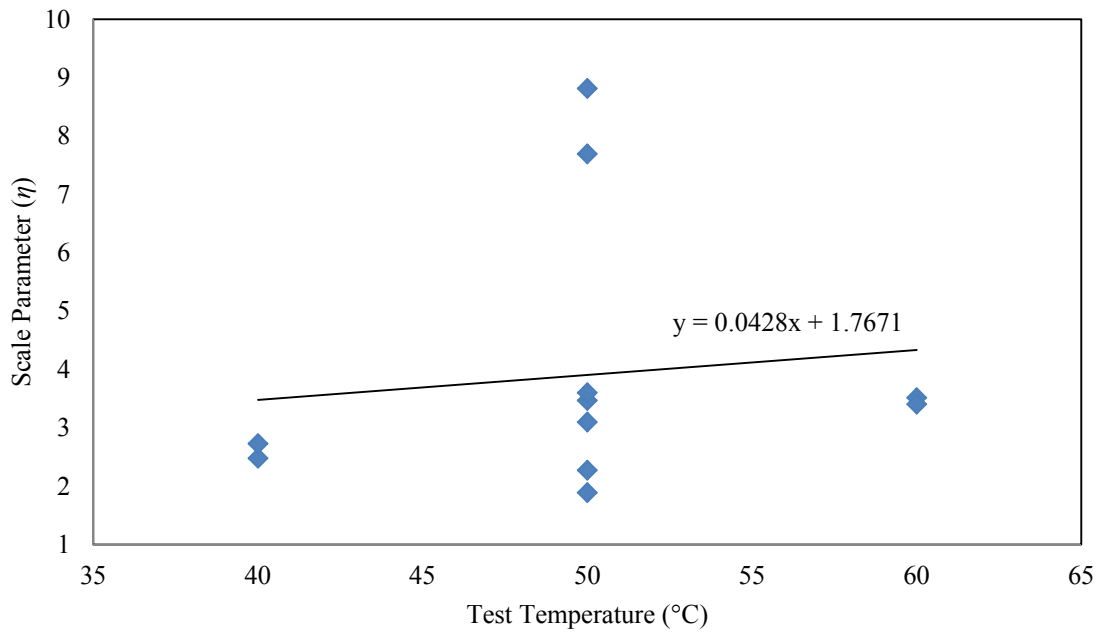

(b)

Figure 5.9 Shape and Scale parameters for PG64-28

Figure 5.10 depicts the generalized line for shape and scale parameters for PG70-22 mixtures at different test temperatures.

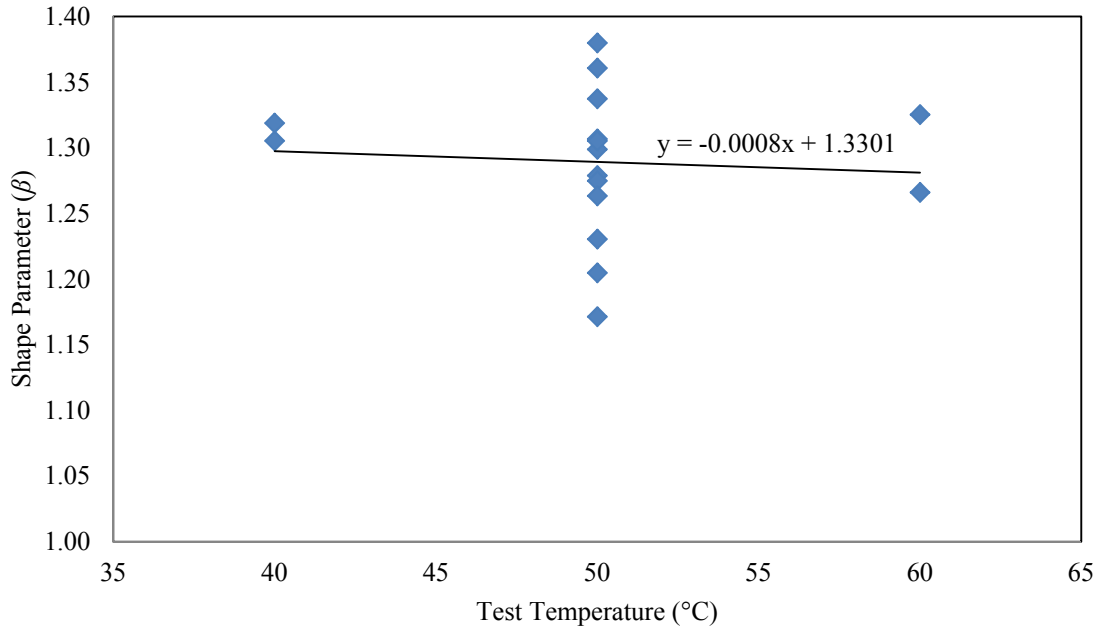

(a)

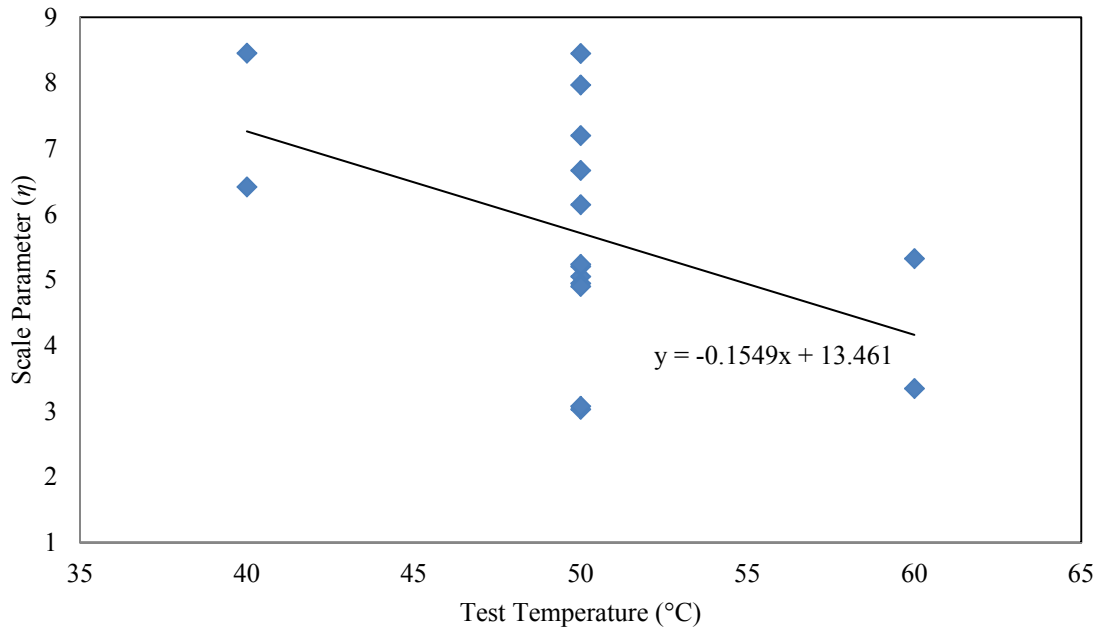

(b)

Figure 5.10 Shape and Scale parameters for PG70-22

Figure 5.11 depicts the generalized line for shape and scale parameters for PG76-22 mixtures at different test temperatures.

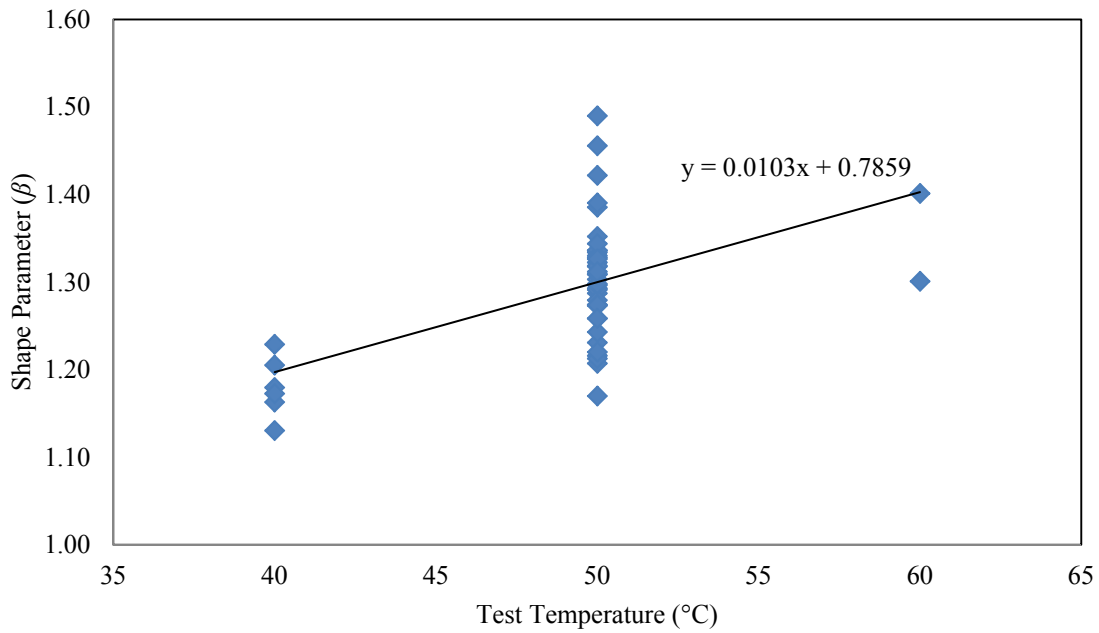

(a)

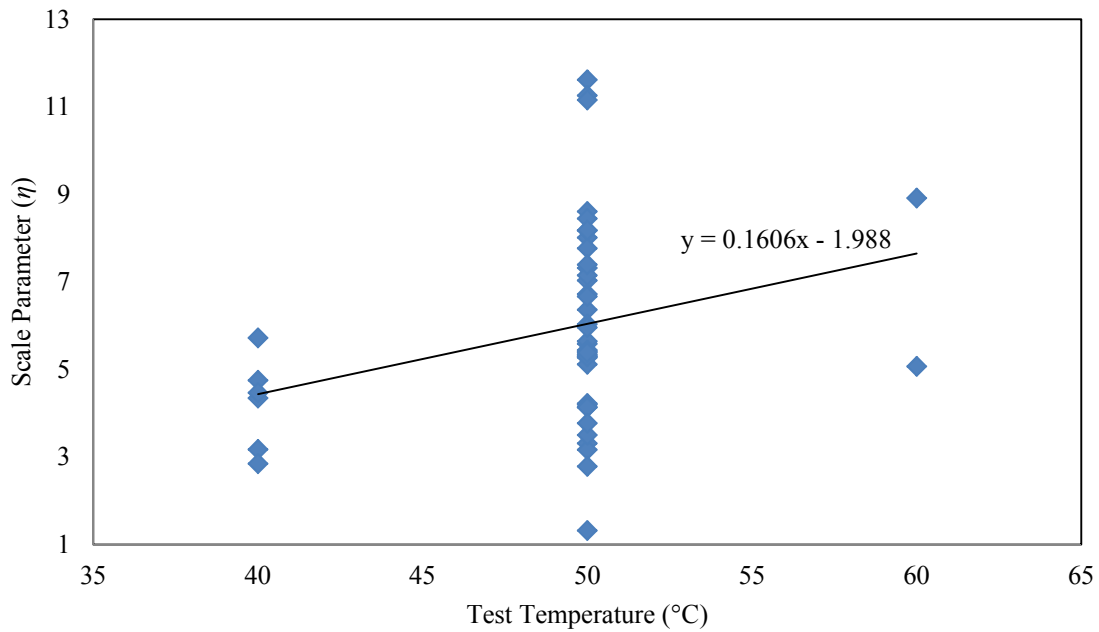

(b)

Figure 5.11 Shape and Scale parameters for PG76-22

5.6 PREDICTED RUTTING AND MODEL FITTING

This section is dedicated to validate and observe the predicted HWTD for AC mixtures and compare them with the measured HWTD results obtained in laboratory. From Equation 8, it is required to define the shape and scale parameters. As defined in previous sections, shape and scale parameters were defined for each of the type of mixtures, gradations, aggregates and binder performance binder grades. These parameters are represented in linear equations in function of test temperature. Equations 9 and 10 represent the shape and scale parameters for each type of mixture, gradation, aggregate and binder.

$$\beta = \frac{\beta_1 + \dots + \beta_n}{n} \quad (9)$$

$$\eta = \frac{\eta_1 + \dots + \eta_n}{n} \quad (10)$$

Where

β = Generalized shape parameter for the n number of shape parameters defined (Type of mixture, gradation, aggregate and binder)

η = Generalized scale parameter for the n number of shape parameters defined (Type of mixture, gradation, aggregate and binder)

In order observe the correlation between Equation 8 and the measured HWTD results in laboratory; five mixtures were selected to compare test results at 50 °C with modeled results of Equation 8. Table 5.4 describes the shape and scale parameters obtained for the mixtures selected. Figures depicted in the present chapter were used to define the different coefficients due type of parameters.

Table 5.4 Predicted Shape and Scale Parameters for AC Mixtures at 50 °C

Mixture	Type of Mixture	Type of Gradation	Type of Aggregate	Type of Binder PG	β Mixture	β Gradation	β Aggregate	β Binder	η Mixture	η Gradation	η Aggregate	η Binder	β	η
1	WMA	Coarse	Sand and Gravel	PG76-22	1.3038	1.3191	1.3207	1.3009	5.9979	6.1785	6.1902	6.0420	1.3111	6.1022
4	HMA	Finer	Basalt	PG64-28	1.2480	1.2466	1.2297	1.2556	4.4381	4.7273	3.7884	3.9071	1.2450	4.2152
12	WMA	Coarse	Sand and Gravel	PG76-22*	1.3038	1.3191	1.3207	1.3442	5.9979	6.1785	6.1902	8.5210	1.3220	6.7219
15	HMA	Finer	Basalt	PG76-22	1.2480	1.2466	1.2297	1.3009	4.4381	4.7273	3.7884	6.0420	1.2563	4.7490
18	HMA	Finer	Quartzite	PG70-22	1.2480	1.2466	1.2957	1.2901	4.4381	4.7273	6.0065	5.7160	1.2701	5.2220

The following figures show the HWTD results obtained in laboratory and the rut depths estimated by Equation 8.

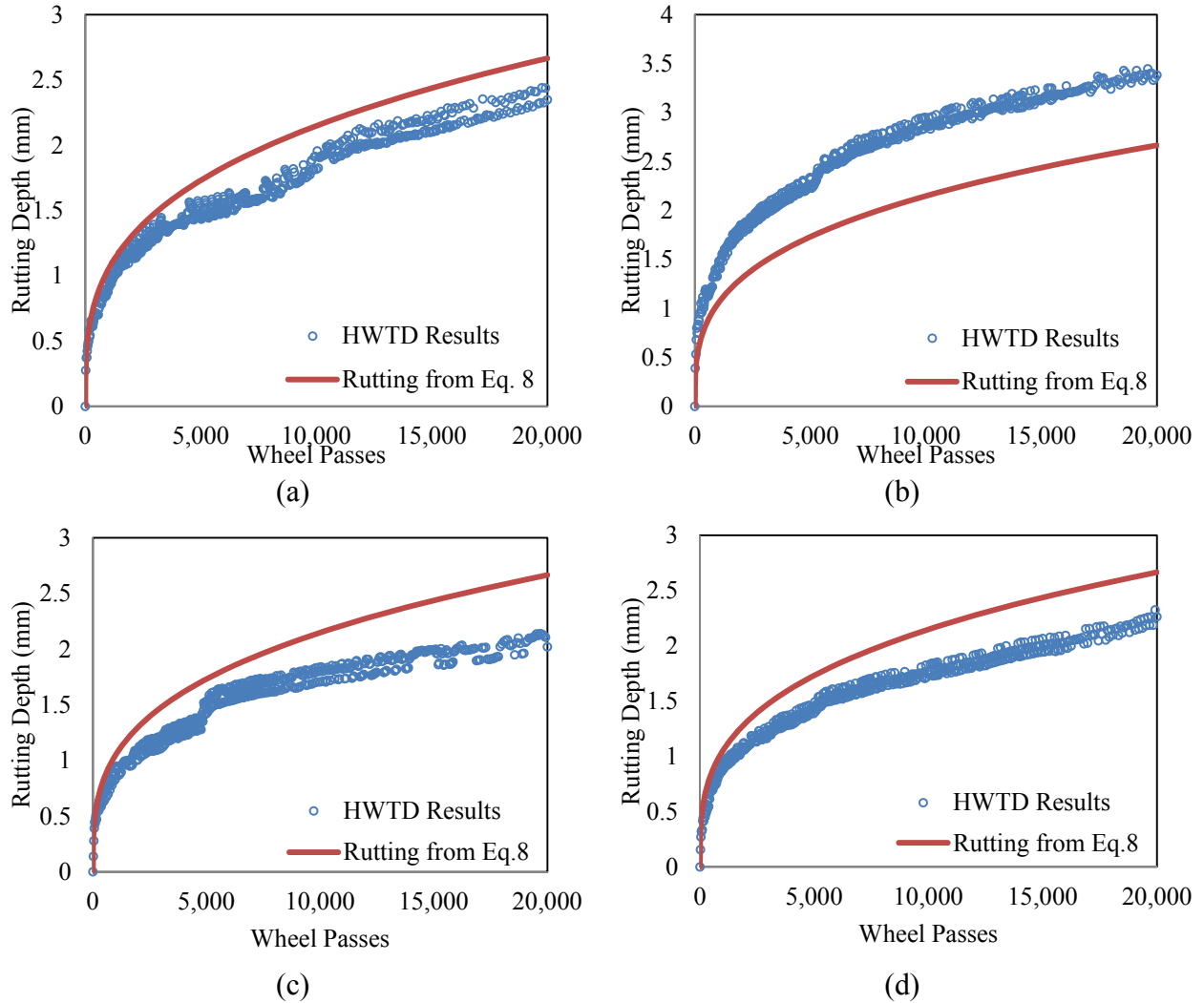

Figure 5.12 HWTB Rutting modeled Eq. 8 for mixture 1

From previous figure, it can be observed a fairly good estimation of rutting depths using the Equation 8. Test (a) and (d) showed better correlations in relationship to the other two tests performed at this temperature.

Figure 5.13 depicts the rutting prediction for Mixture 4 using equation 8 and its corresponding parameters. HWTB results and predicted rutting are depicted in the following figure.

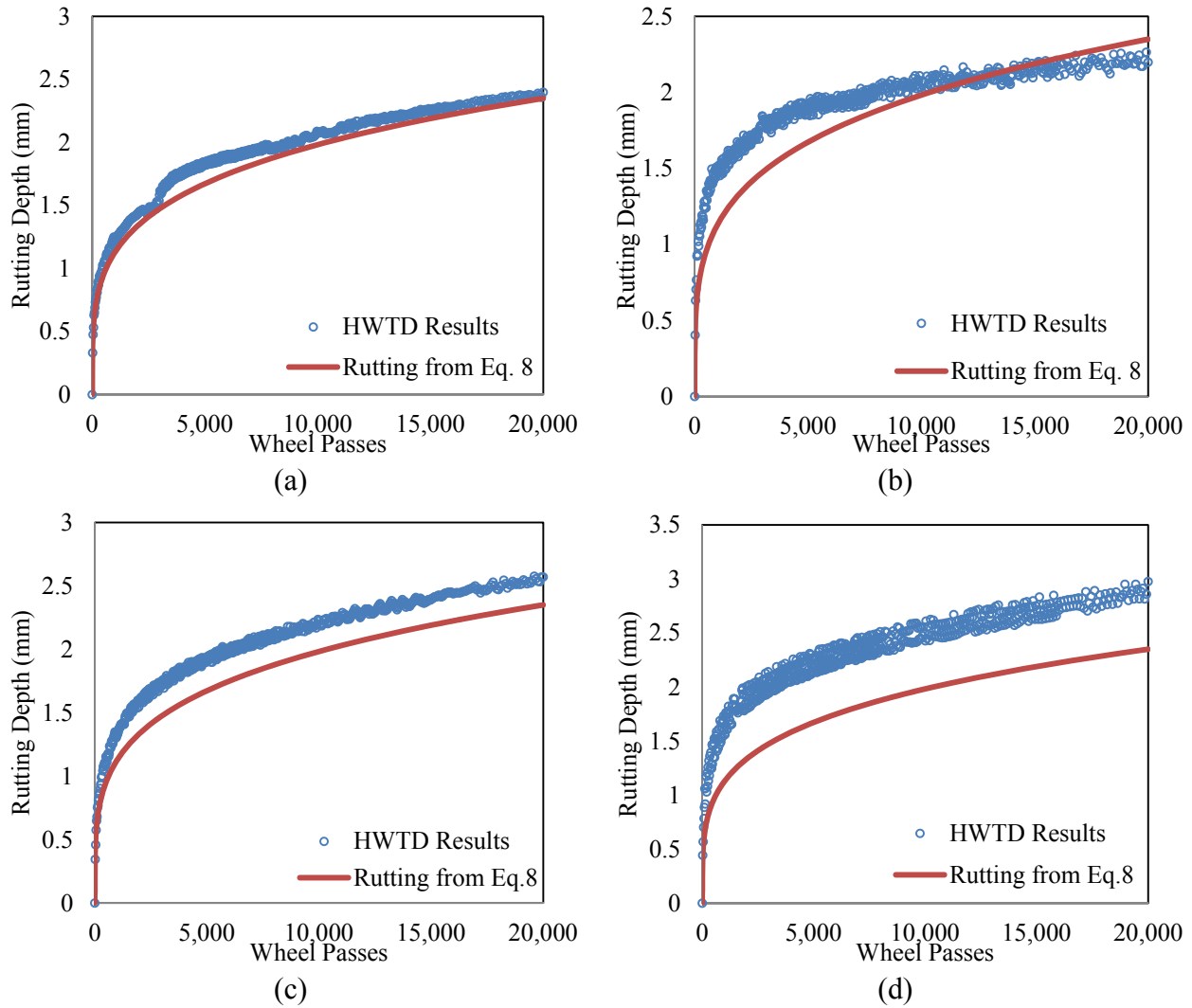

Figure 5.13 HWTB Rutting modeled Eq. 8 for mixture 4

From previous figure, it can be observed a good estimation of rutting depths using the Equation 8 for test (a) and (c). For test (b) a fairly good correlation was observed. Differently, test (d) results showed a poor correlation with the rutting predicted by Equation 8.

Figure 5.14 depicts the rutting prediction for Mixture 12 using equation 8 and its corresponding parameters. HWTB results and predicted rutting are depicted in the following figure.

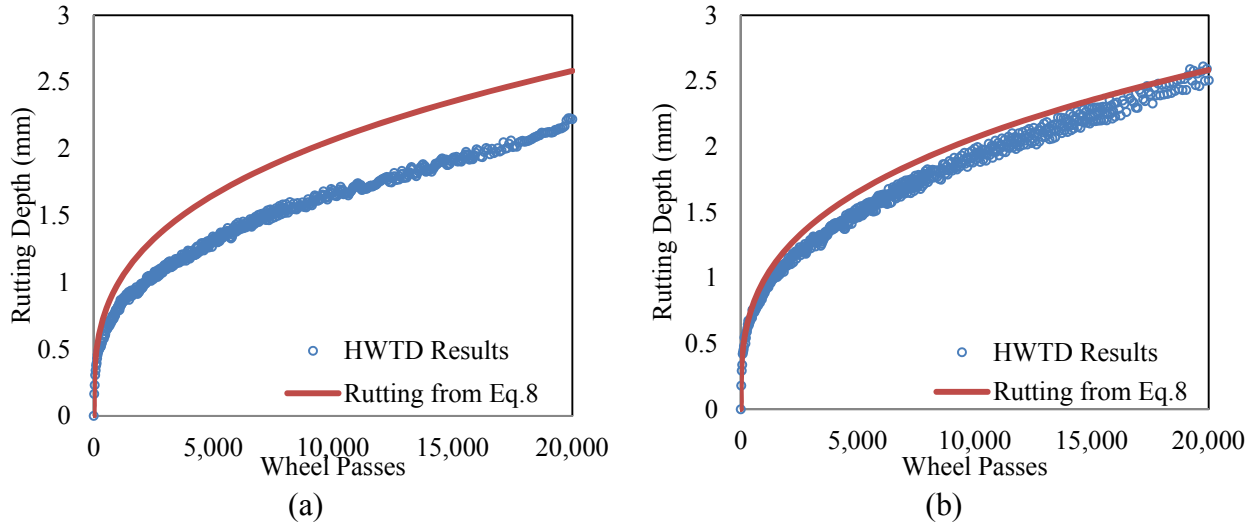
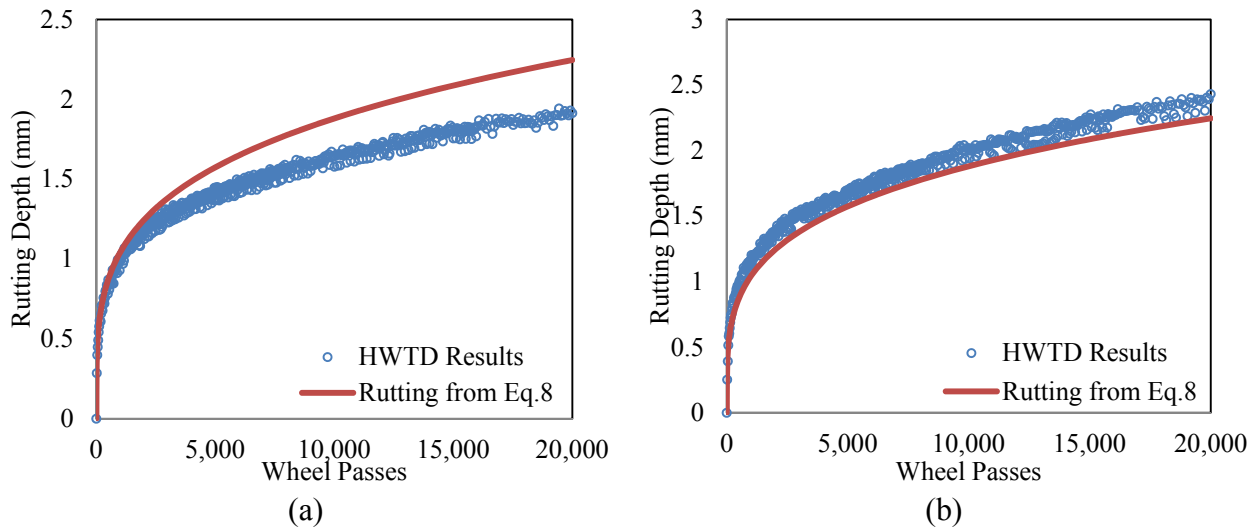
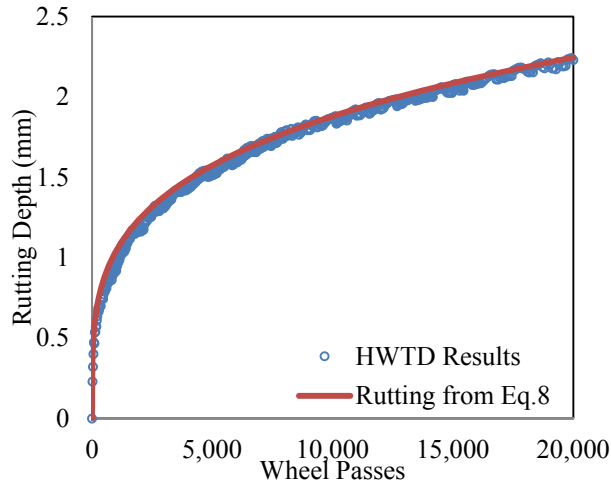

Figure 5.14 HWTD Rutting modeled Eq. 8 for mixture 12

Figure 5.14 showed a fair correlation between predicted rutting by equation 8 and HWTD results obtained in the laboratory for this mixture. Differently, test (b) showed a good estimation of the HWTD results obtained for Mixture 12.

Figure 5.15 depicts the rutting prediction for Mixture 15 using equation 8 and its corresponding parameters. HWTD results and predicted rutting are depicted in the following figure.





(c)

Figure 5.15 HWTB Rutting modeled Eq. 8 for mixture 15

Previous figure showed a fair correlation for test (a) when rutting was predicted for mixture 15. Rutting estimated by equation 8 for test (b) showed a good interrelation with measured HWTB results. For test (c), excellent correlation was observed between predicted and measured data point for all HWTB phases.

Figure 5.16 depicts the rutting prediction for Mixture 18 using equation 8 and its corresponding parameters. HWTB results and predicted rutting are depicted in the following figure.

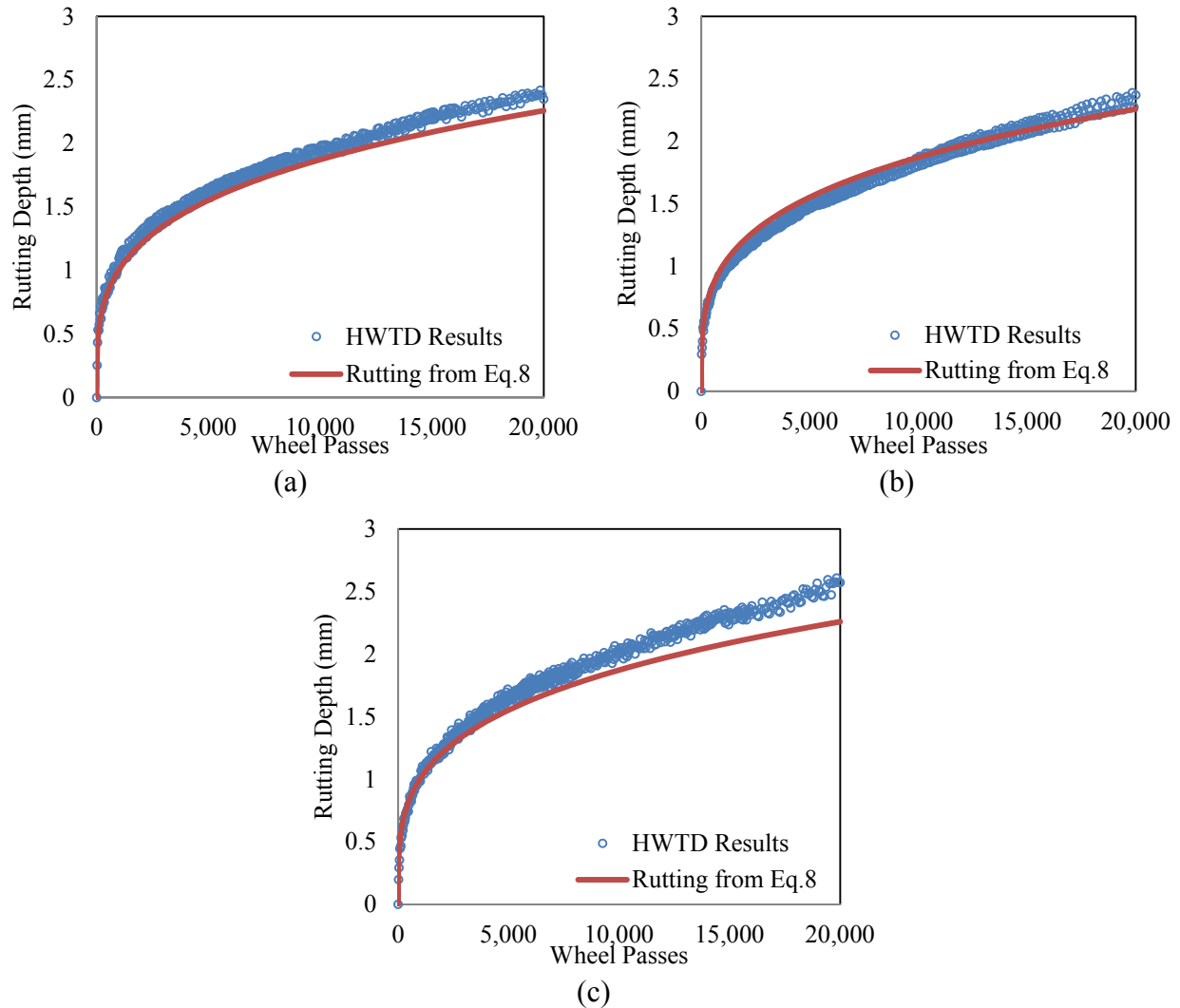

Figure 5.16 HWTB Rutting modeled Eq. 8 for mixture 18

From previous figure, it can be observed that test (a) and test (b) showed a close correlation between predicted and measured results. For test (c), a good correlation was observed with less impact than previous tests. Anyhow, it was shown that rutting estimated by equation 8 for this mixture showed close results compared to results measured in the real test.

Chapter 6 CONCLUSIONS AND RECOMMENDATIONS

6.1 CONCLUSIONS

From the analyses and discussions of laboratory test results presented in preceding chapters, the following conclusions can be drawn:

- HMA/WMA HWTD results are sensitive to test temperature. AC mixtures tested at 40 °C did not show stripping in any of the twenty mixtures tested. The effect of increasing temperature to 50 °C in the test showed stripping results for mixtures 6 and 7. Similarly, mixtures 2 and 5 showed stripping when temperature was increased from 50 to 60 °C.
- WMA mixtures performed better at 40, 50 and 60 °C HWTD test temperature compared to HMA mixtures in terms of maximum rutting depth and maximum number of wheel passes. Similarly, better performance was observed in HWTD phases for WMA mixtures. HMA/WMA mixtures did not show a solid correlation between AV contents and type of mixture when HWTD was conducted at the mentioned temperatures. The effect of gradation in the type of mixture showed better performance for coarser HMA mixtures. Finer mixtures showed higher tendency to reach stripping in both type of mixtures. No relationship was observed for type of aggregate and type of mixture, aggregates perform independently. For binder PG, better performance was observed for binder grades in HMA mixtures.
- AC mixtures with coarser gradation showed a significant improvement in rutting results compared to finer mixtures at any of the defined test temperatures. AV contents in range 2 showed better results in both of the studied gradations. The effect of aggregate in type of gradation showed better performance of finer mixtures in the presence of same

aggregates when stripping was not reached. Binder PG showed better results in coarser mixtures.

- HWTD results are very sensitive to the type of aggregate. Shale and dacite showed stripping at standard temperature (50 °C) differently from other aggregates. Sand and gravel showed a high variation in results with low and high performances. Similarly, river deposits showed discrepancy in HWTD results showing stripping at 60 °C, differently from sand and gravel. Basalt and quartzite showed good results in the defined temperatures. Similarly performance was observed for limestone at 40 and 50 °C. Stripping was observed for this aggregate at 60 °C with lower impressions than river deposits, shale and dacite. Limestone showed better results from the seven studied aggregates. No important correlation for AV contents was observed.
- Lower binder grades showed higher rutting depths at 40 °C. At 50 °C, PG64-28 and PG76-28 showed stripping at the standard test temperature (50 °C). Anyhow, PG64-28 showed good results at this temperature along with PG70-22. PG76-22 showed high variability in results with low and high rutting depths. Differently from other binder grades, no sign of stripping was observed for PG70-22 at any of the three set temperatures. Lower binder grades showed higher susceptibility in the post-compaction phase. PG70-22 and PG76-22 showed high slopes in the creep phase of the test. The use of a modified polymer in PG76-22 showed rutting depth results in the average area of results without the polymer. The variation of AV contents did not show a solid correlation with the type of binder grade.
- Performance binder grade do not help to reduce stripping and rutting distresses when used with finer gradations.

- Good correlation was observed between the defined Weibull function and HWTD results measured in laboratory.

6.2 RECOMMENDATIONS

The following recommendations are made for future studies:

- Different AC mixtures parameters are not yet studied in order to analyze the effect in AC mixtures for rutting and stripping distresses in HWTD. The study of new parameters in HWTD will give a better understanding of rutting and stripping distresses of AC mixtures in this test.
- Permeability of AC is important to understand the effect of moisture damage action. It is recommended to conduct permeability tests in AC mixtures in order to understand the effect of this factor due HWTD is conducted under water.
- Low correlation was observed between field performance and HWTD in literature review. It is recommended to conduct HWTD in field cores collected from sites and correlate results with mixtures collected in site and compacted in laboratory.
- Weibull function showed an important correlation to predict rutting. Anyhow, stripping phase in HWTD cannot be modeled using this function. It is recommended to develop a model in order to predict the sensibility of AC mixtures to reach this phase.

REFERENCES

1. Aschenbrener, T., and Far, N. (1994) "Influence of Compaction Temperature and Anti-Stripping Treatment on the Results from Hamburg Wheel-Tracking Device" Publication No. CDOT-DTD-R-94-9. Colorado Department of Transportation
2. Aschenbrener, T., Terrel, R. and Zamora, R. (1994). "Comparison of the Hamburg Wheel-Tracking Device and the Environmental conditioning System to Pavements of Known Stripping Performance" Report No. CDOT-DTD-R-94-1, Colorado Department of Transportation
3. AASHTO T 168 (2011). "Standard Method of Test for Sampling Bituminous Paving Mixtures" *Standard Specifications for Transportation Materials and Methods of Sampling and Testing*, AASHTO, Washington, D.C.
4. AASHTO T 209 (2011). "Standard Method of Test for Theoretical Maximum Specific Gravity (Gmm) and Density of Hot Mix Asphalt (HMA)" *Standard Specifications for Transportation Materials and Methods of Sampling and Testing*, AASHTO, Washington, D.C.
5. AASHTO T 312 (2011). "Standard Method of Test for Preparing and Determining the Density of Hot Mix Asphalt (HMA) Specimens by Means of the Superpave Gyratory Compactor" *Standard Specifications for Transportation Materials and Methods of Sampling and Testing*, AASHTO, Washington, D.C.
6. AASHTO T 324 (2011). "Standard Method of Test for Hamburg Wheel-Track Testing of Compacted Hot Mix Asphalt (HMA)" *Standard Specifications for Transportation Materials and Methods of Sampling and Testing*, AASHTO, Washington, D.C.
7. AASHTO T 166 (2005). "Standard Method of Test for Bulk Specific Gravity (Gmb) of Compacted Hot Mix Asphalt (HMA) Using Saturated Surface-Dry Specimens" *Standard Specifications for Transportation Materials and Methods of Sampling and Testing*, AASHTO, Washington, D.C.
8. Long, F.M. (2001). "Permanent Deformation of Asphalt Concrete Pavements: A Nonlinear Viscoelastic Approach to Mix Analysis and Design" Engineering – Civil and Environmental Engineering, University of California, Berkeley

9. Garba, R. (2002). “Permanent Deformation Properties of Asphalt Concrete Mixture” Department of Road and Railway Engineering, Norwegian university of Science and Technology, NTNU
10. Muraya, P. M. (2007). “Permanent Deformation of Asphalt Mixtures” Faculty of Civil Engineering and Geosciences, Delft University of Technology
11. Topal, A. and Sengoz B. (2005). “Determination of fine aggregate angularity in relation with the resistance to rutting of hot-mix asphalt” *Construction and Building Materials* Vol. 19 pp. 155–163
12. Long, F.M. (2001). “Permanent Deformation of Asphalt Concrete Pavements: A Nonlinear Viscoelastic Approach to Mix Analysis and Design” Engineering – Civil and Environmental Engineering, University of California, Berkeley
13. Lu, Q. (2005). “Investigation of conditions for Moisture Damage in Asphalt Concrete and Appropriate Laboratory Test Methods” University of California Transportation Center
14. Santucci, L. (2002). “Moisture Sensitivity of Asphalt Pavements” Technology Transfer Program, UC-Berkley’s Institute of Transportation Studies
15. Terrel, R. L., and Al-Swailmi, S. (1994). “Water Sensitivity of Asphalt–Aggregate Mixes: Test Selection” SHRP Report A-403. Strategic Highway Research Program, National Research Council, Washington, D.C.
16. Khosla, N. (2005). “Tensile Strength – A Design and Evaluation Tool for Superpave Mixtures” HWY 200-14
17. Little, D. N. and Jones IV, D. R. (2003). “Chemical and Mechanical Processes of Moisture Damage in Hot Mix Asphalt Pavements.” *Transportation Research Board National Seminar*. San Diego, California, pp. 37-70.
18. Ebrahim, A. and Behiry, E. (2013). “Laboratory Evaluation of Resistance to Moisture Damage in Asphalt Mixture” *Ain Shams Engineering Journal* (2013) 4, 351-363
19. Aschenbrener, T. and Far, N. (1994). “Influence of Compaction Temperature and Anti-Stripping Treatment on the Results from Hamburg Wheel-Tracking Device” Publication No. CDOT-DTD-R-94-9. Colorado Department of Transportation
20. Izzo, R. and Tahmoressi, M. (1998). “Evaluation of the Use of the Hamburg Wheel Tracking Device for Moisture Susceptibility of Hot Mix Asphalt” Report No. DHT-45, Texas Department of Transportation

21. Yildirim, Y., Jayawickrama, P., Hossain, M., Alhabshi, A., Yildirim, C., Fortier Smit, A. and Little, D. (2007). “Hamburg Wheel Tracking Database Analysis” Report 0-1707-7, Texas Department of Transportation
22. Rahman, F. and Hossain, M. (2014). “Review and Analysis of Hamburg Wheel Tracking Device Test Data” Report No. KS-14-1, Kansas Department of Transportation
23. Aschenbrener, T. and Curier, G, (1993). “Influence of Testing Variables on the Results from the Hamburg Wheel-Tracking Device” Colorado Department of Transportation
24. Yildirim, Y. and Kennedy, T. (2001). “Correlation of Field Performance to Hamburg Wheel Tracking Device Results” Report No. FHWA/TX-04/0-4185-1, Texas Department of Transportation
25. Bandini, P. and Cortes, D. (2014). “Evaluation of Rutting and Stripping Potential of Selected HMA/WMA Mixes Using Hamburg Wheel Tracking Device (HWTDD)” Report No. NM15MSC-02-010, New Mexico Department of Transportation Research Bureau
26. Aschenbrener, T. (1995). “Evaluation of Hamburg Wheel Tracking Device to Predict Moisture Damage in Hot-Mix Asphalt.” In *Transportation Research Record: Journal of the Transportation Research Board*, No. 1492, Transportation Research Board of the National Academies, Washington, D.C., 1995, pp. 193–201.
27. Sel, I., Yildirim, Y. and Ozhan, H. (2014). “Effect of Test Temperature on Hamburg Wheel-Tracking Device Testing” American Society of Civil Engineers, Volume 26
28. Nielson, J. (2010). “Development of a Testing Temperature to be Used with the Hamburg Wheel Tracking Device on Asphalt Mixtures that Utilize Performance Grade Binders” Master of Science Thesis, The University of Utah
29. Yildirim, Y. and Stokoe, K. (2006). “Analysis of Hamburg Wheel Tracking Device Results in Relation to Field Performance” Report No. FHWA/TX-06/0-4185-5, Texas Department of Transportation
30. Gogula, A., Hossain, M., Boyer, J., and Romanoschi, S. (2003). “Effect of PG Binder Grade and Source on Performance of Superpave Mixtures under Hamburg Wheel Tester.” *Mid-Continent Transportation Research Symposium, Ames, Iowa*. August 2003
31. Solaimanian, M. and Pendola, G. (2011). “Aggregate Behavior in the Hamburg Wheel Tracking Device” Texas Department of Transportation

32. Izzo, R. and Tahmoressi, M. (1998). "Evaluation of the Use of the Hamburg Wheel Tracking Device for Moisture Susceptibility of Hot Mix Asphalt" Report No. DHT-45, Texas Department of Transportation
33. Yildirim, Y. and Kennedy, T. (2002). "Hamburg Wheel Tracking Device Results on Plant and Field Cores Produced Mixtures" Report No. FHWA/TX-04/0-4185-2, Texas Department of Transportation
34. Lu, Q. and Harvey, T. (2006). "Evaluation of Hamburg Wheel Tracking Device Test with Laboratory and Field Performance Data" Transportation Research Board, Vol. 1970, pp. 25-44
35. Khandal, P., and Cooley, A. (2002). "Coarse versus Fine-Graded Superpave Mixtures Comparative Evaluation of Resistance to Rutting" Publication No. NCAT Report 02-02. National Center for Asphalt Technology.
36. Gokhale, S., Choubane, B., Sholar, G., and Moseley, H. (2006). "Evaluation of Coarse and Fine Graded Superpave Mixtures under Accelerated Pavement Testing." Publication No. FL/DOT/SMO/06-494. Florida Department of Transportation.
37. Golalipour, A., Jamshidi, E., Niazi, Y., Afsharikia, Z., and Khadem, M. (2012). "Effect of Aggregate Gradation on Rutting Asphalt Pavements." In *Procedia Social and Behavioral Sciences. Vol 53*, pp. 440-449.
38. Manal A., and Attia, M. (2013). "Impact of Aggregate Gradation and Type of Hot Mix Asphalt Rutting in Egypt." In *International Journal of Engineering Research and Application, Vol. 3, Issue 4*, pp. 2249-2258.
39. Habeeb, H., Chandra, S., and Nashaat, Y. (2012). "Estimation of Moisture Damage and Permanent Deformation in Asphalt Mixture from Aggregate Gradation." In *KSCE Journal of Civil Engineering, Vol. 18(6)*, pp. 1655-1663.
40. Kanitpong, K., Charoentham, N., and Likitlersuang, S. (2012). "Investigation on the Effects of Gradation and Aggregate Type to Moisture Damage of Warm Mix Asphalt Modified with Sasobit." In *International Journal of Pavement, Vol. 13:5*, pp. 451-458.
41. Tarefder, R. and Zaman, M. (2002). *Evaluation of Rutting Potential of Hot Mix Asphalt Using the Asphalt Pavement Analyzer*. Publication No. Final Report Item 2153; ORA 125-6660. Oklahoma Department of Transportation.
42. Kassem, E., Masad, E., Lytton, R., and Chowdhury, A. (2011). "Influence of Air Voids

- on Mechanical Properties of Asphalt Mixtures.” In *Journal of Road Materials and Pavement Designs*, Vol. 12, pp. 493-524.
43. Zaumanis, M. Warm Mix Asphalt Investigation. MSc. Thesis, Technical University of Denmark, 2011.
 44. Perkins, S. (2009) “Synthesis of Warm Mix Asphalt Paving Strategies for use in Montana Highway Construction.” Publication No. FHWA/MT-09-009/8117-38. Montana Department of Transportation
 45. Liva, G., and McBroom, D. (2009). “Warm Mix Asphalt.” Research Report. Montana Department of Transportation
 46. Hurley, G., and Prowell, B. (2006). “Evaluation of Evotherm for use in Warm Mix Asphalt” Publication No. NCAT Report 06-02. National Center for Asphalt Technology
 47. Aschenbrener, T., Schiebel, B., and West, R. (2011). “Three-Year Evaluation of the Colorado Department of Transportation’s Warm-Mix Asphalt Experimental Feature on I-70 in Silverthorne, Colorado.” Publication No. NCAT Final Report 11-02. National Center for Asphalt Technology
 48. Jones, D., Wu, R., Tsai, B., and Harvey, T. (2011). “Warm-Mix Asphalt Study: Test Track Construction and First-Level Analysis of Phase 3a HVS and Laboratory Testing. (Mix Design #1).” Publication No. CA13-2221A. California Department of Transportation
 49. Kuang, Y. (2012). “Evaluation of Evotherm as a WMA technology compaction and anti-strip additive.” Graduate Theses and Dissertations. Paper No. 12370. Iowa State University, 2012.
 50. Coleri, E., Tsai, B., and Monismith, C. (2008). “Pavement Rutting Performance Prediction by Integrated Weibull Approach.” In *Transportation Research Record: Journal of the Transportation Research Board*, No. 2087, Transportation Research Board of the National Academies, Washington, D.C., 2008, pp. 120–130.
 51. Peng, T., Wang, X., and Chen, S. (2013). Pavement Performance Prediction Model Based on Weibull Distribution. In *Applied Mechanics and Materials*, Vol. 378, pp. 61-64
 52. Yin, F., Arambula, E., Lytton, R., Martin, A., and Garcia, L. (2014). “Novel Method for Moisture Susceptibility and Rutting Evaluation Using Hamburg Wheel Tracking Test.” In *Transportation Research Record: Journal of the Transportation Research Board*, No.

2446, Transportation Research Board of the National Academies, Washington, D.C., 2014, pp. 1–7.

53. VanFrank, K. and Romero, P. (2013). “On the Variability of Results from the Hamburg Wheel Tracker Device” 49th ASC Annual International Conference Proceedings

54. Schram, S., Williams, C., and Bus, A. (2014). “Reporting Results from the Hamburg Wheel Tracking Device.” In *Transportation Research Record: Journal of the Transportation Research Board*, No. 2446, Transportation Research Board of the National Academies, Washington, D.C., 2014, pp. 89-98.

APPENDIX

HWTD Results Mixture 1 and 2 (mm)

Number of Wheel Passes	Mixture 1								Mixture 2							
	Temperature								Temperature							
	50	50	50	50	40	40	60	60	40	40	50	50	50	50	60	60
0	0.00	0.00	0.00	0.00	0.00	0.00	0.00	0.00	0.00	0.00	0.00	0.00	0.00	0.00	0.00	0.00
100	0.46	0.75	0.43	0.34	0.41	0.55	0.59	0.53	0.43	0.31	0.45	0.66	0.39	0.36	0.64	0.71
200	0.54	0.95	0.57	0.48	0.51	0.64	0.76	0.71	0.53	0.37	0.59	0.86	0.44	0.48	0.74	0.91
300	0.62	0.96	0.62	0.51	0.56	0.60	0.81	0.84	0.59	0.4	0.68	0.92	0.5	0.45	0.87	0.93
400	0.69	1.04	0.70	0.66	0.57	0.62	0.86	0.90	0.69	0.49	0.75	0.99	0.57	0.53	0.97	1.06
500	0.71	1.17	0.64	0.73	0.65	0.74	0.99	0.99	0.72	0.51	0.8	1.01	0.64	0.54	1.02	1.12
600	0.76	1.14	0.73	0.77	0.67	0.73	1.07	1.20	0.81	0.58	0.86	1.1	0.68	0.55	1.09	1.15
700	0.78	1.20	0.79	0.82	0.64	0.70	1.12	1.21	0.76	0.58	0.93	1.16	0.67	0.63	1.15	1.33
800	0.83	1.32	0.84	0.82	0.69	0.76	1.16	1.31	0.83	0.61	0.87	1.19	0.7	0.71	1.22	1.27
900	0.84	1.40	0.90	0.85	0.74	0.82	1.16	1.32	0.86	0.65	0.95	1.21	0.75	0.69	1.27	1.4
1000	0.91	1.43	0.89	0.92	0.72	0.78	1.13	1.30	0.92	0.65	1.03	1.22	0.73	0.65	1.28	1.34
1100	1.01	1.41	0.92	0.97	0.70	0.80	1.23	1.36	0.92	0.71	1.02	1.29	0.72	0.65	1.35	1.41
1200	1.00	1.55	0.89	0.97	0.78	0.87	1.29	1.37	1	0.71	1.06	1.24	0.78	0.8	1.4	1.51
1300	1.01	1.59	0.96	1.00	0.74	0.84	1.22	1.45	1.02	0.7	1.05	1.28	0.85	0.8	1.39	1.5
1400	1.12	1.63	0.99	0.97	0.80	0.76	1.27	1.43	1.05	0.74	1.04	1.28	0.77	0.8	1.47	1.54
1500	1.12	1.69	0.99	0.98	0.80	0.91	1.32	1.49	1.06	0.8	1.07	1.3	0.8	0.72	1.46	1.52
1600	1.07	1.66	0.95	1.05	0.74	0.78	1.35	1.46	1.09	0.81	1.05	1.31	0.92	0.85	1.54	1.57
1700	1.16	1.76	0.96	1.03	0.78	0.93	1.36	1.48	1.08	0.85	1.08	1.34	0.87	0.74	1.54	1.65
1800	1.19	1.72	1.06	1.04	0.84	0.80	1.34	1.49	1.08	0.83	1.12	1.37	0.83	0.87	1.56	1.73
1900	1.17	1.80	1.07	1.12	0.76	0.80	1.45	1.56	1.12	0.81	1.14	1.35	0.81	0.77	1.61	1.69
2000	1.13	1.81	1.09	1.07	0.81	0.90	1.45	1.63	1.09	0.83	1.16	1.41	0.85	0.86	1.62	1.69
2100	1.14	1.84	1.03	1.10	0.77	0.91	1.50	1.63	1.11	0.86	1.09	1.38	0.92	0.9	1.68	1.81
2200	1.14	1.85	1.14	1.11	0.85	0.98	1.54	1.64	1.13	0.86	1.16	1.41	0.83	0.79	1.7	1.79
2300	1.21	1.86	1.17	1.16	0.83	0.98	1.48	1.65	1.1	0.88	1.18	1.45	0.96	0.79	1.71	1.79
2400	1.21	1.93	1.19	1.14	0.84	0.94	1.51	1.70	1.09	0.89	1.12	1.45	0.87	0.84	1.71	1.9
2500	1.26	1.91	1.19	1.17	0.81	0.93	1.56	1.67	1.16	0.9	1.22	1.46	0.99	0.92	1.77	1.87
2600	1.31	1.97	1.20	1.23	0.87	0.98	1.60	1.73	1.11	0.92	1.21	1.49	0.88	0.94	1.78	1.91
2700	1.23	1.91	1.18	1.16	0.82	0.90	1.63	1.73	1.11	0.9	1.17	1.48	0.96	0.94	1.82	1.87
2800	1.31	1.98	1.16	1.19	0.88	0.89	1.58	1.74	1.12	0.93	1.14	1.53	0.9	0.95	1.82	1.9
2900	1.27	2.04	1.10	1.18	0.84	0.88	1.63	1.73	1.14	0.91	1.23	1.53	0.89	0.94	1.86	1.93
3000	1.34	2.05	1.18	1.27	0.90	0.88	1.67	1.74	1.13	0.94	1.18	1.49	0.95	0.89	1.87	1.97
3100	1.28	1.97	1.21	1.20	0.89	1.03	1.66	1.79	1.2	0.92	1.17	1.56	1.01	0.86	1.9	2
3200	1.39	1.99	1.28	1.25	0.84	0.89	1.65	1.77	1.18	0.92	1.23	1.52	1.04	0.95	1.9	2.06
3300	1.38	2.00	1.18	1.28	0.89	1.05	1.66	1.80	1.14	0.97	1.18	1.52	1.05	0.98	1.94	2.09
3400	1.34	2.12	1.27	1.25	0.91	0.90	1.72	1.85	1.23	0.97	1.2	1.56	1.03	0.86	1.94	2.12

3500	1.38	2.09	1.20	1.27	0.94	0.99	1.74	1.81	1.18	0.98	1.25	1.54	0.99	1	1.97	2.08
3600	1.35	2.10	1.31	1.28	0.87	0.99	1.69	1.85	1.24	0.98	1.28	1.54	0.95	0.9	2.02	2.09
3700	1.37	2.09	1.28	1.29	0.93	0.92	1.75	1.90	1.23	0.99	1.29	1.6	0.94	1	2.02	2.12
3800	1.38	2.08	1.21	1.28	0.89	0.98	1.66	1.90	1.2	1	1.31	1.54	0.99	0.99	2.05	2.19
3900	1.39	2.15	1.22	1.32	0.93	1.00	1.80	1.86	1.18	1.01	1.29	1.58	1.1	0.94	2.08	2.19
4000	1.40	2.13	1.31	1.32	0.88	1.02	1.83	1.90	1.19	1	1.3	1.58	1.06	1	2.07	2.2
4100	1.40	2.21	1.34	1.33	0.91	1.02	1.85	1.90	1.2	1.02	1.29	1.61	1	0.92	2.09	2.2
4200	1.40	2.17	1.23	1.35	0.94	1.01	1.83	1.98	1.2	1.02	1.34	1.61	0.96	1.05	2.14	2.22
4300	1.43	2.15	1.37	1.37	0.95	0.95	1.91	1.95	1.21	1.02	1.27	1.59	1.02	0.9	2.09	2.25
4400	1.42	2.20	1.26	1.34	0.95	0.99	1.86	1.90	1.2	1.03	1.33	1.64	1.12	1.03	2.11	2.27
4500	1.56	2.17	1.38	1.35	0.96	1.11	1.83	1.98	1.19	1.04	1.3	1.67	1.05	1.03	2.15	2.28
4600	1.44	2.22	1.35	1.35	0.91	1.03	1.85	1.96	1.28	1.03	1.28	1.62	1.01	0.97	2.17	2.28
4700	1.43	2.29	1.28	1.36	0.92	0.97	1.77	1.93	1.29	1.04	1.31	1.63	0.99	1.1	2.21	2.3
4800	1.50	2.21	1.42	1.41	0.92	1.05	1.87	2.00	1.27	1.01	1.32	1.67	1.05	0.96	2.15	2.32
4900	1.54	2.26	1.50	1.44	0.96	0.98	1.86	1.99	1.28	1.01	1.36	1.66	1.14	1.08	2.22	2.32
5000	1.44	2.32	1.51	1.43	0.97	1.06	1.90	2.01	1.26	1.02	1.34	1.58	1.12	0.98	2.22	2.32
5200	1.56	2.29	1.48	1.47	1.03	1.02	1.90	2.05	1.25	1.04	1.33	1.66	1.03	0.98	2.21	2.33
5400	1.47	2.40	1.58	1.57	1.02	1.02	1.93	2.03	1.29	1.02	1.28	1.69	1.08	0.99	2.27	2.36
5600	1.46	2.52	1.51	1.49	1.03	1.11	1.93	2.06	1.3	1.05	1.38	1.68	1.17	1.1	2.32	2.38
5800	1.48	2.44	1.52	1.53	0.96	1.19	1.95	2.11	1.26	1.06	1.41	1.69	1.05	1.15	2.35	2.44
6000	1.59	2.56	1.66	1.52	0.96	1.11	2.05	2.13	1.25	1.09	1.36	1.7	1.21	1.11	2.39	2.52
6200	1.56	2.49	1.54	1.56	1.01	1.11	2.08	2.12	1.27	1.07	1.44	1.71	1.11	1.05	2.39	2.48
6400	1.51	2.50	1.56	1.63	0.98	1.16	2.10	2.15	1.32	1.1	1.37	1.76	1.1	1.13	2.44	2.56
6600	1.60	2.65	1.70	1.55	1.04	1.11	2.09	2.16	1.3	1.1	1.37	1.75	1.13	1.2	2.51	2.57
6800	1.61	2.57	1.67	1.66	1.05	1.09	2.17	2.19	1.26	1.09	1.4	1.68	1.2	1.05	2.52	2.56
7000	1.56	2.60	1.67	1.61	1.01	1.15	2.21	2.22	1.33	1.09	1.38	1.77	1.24	1.19	2.45	2.59
7200	1.58	2.72	1.73	1.58	1.08	1.18	2.26	2.27	1.31	1.13	1.43	1.75	1.07	1.07	2.51	2.66
7400	1.57	2.63	1.69	1.60	1.07	1.19	2.22	2.31	1.29	1.13	1.48	1.77	1.24	1.08	2.63	2.65
7600	1.59	2.66	1.70	1.65	1.03	1.18	2.33	2.36	1.37	1.15	1.44	1.82	1.21	1.1	2.66	2.65
7800	1.73	2.68	1.62	1.67	1.02	1.20	2.30	2.34	1.31	1.16	1.46	1.79	1.16	1.09	2.59	2.68
8000	1.61	2.69	1.73	1.67	1.01	1.16	2.37	2.33	1.35	1.17	1.46	1.81	1.14	1.27	2.67	2.73
8200	1.63	2.69	1.76	1.66	1.06	1.13	2.31	2.39	1.38	1.18	1.5	1.85	1.09	1.14	2.7	2.76
8400	1.63	2.74	1.65	1.67	1.08	1.11	2.40	2.38	1.39	1.16	1.53	1.86	1.13	1.27	2.75	2.84
8600	1.75	2.72	1.74	1.66	1.08	1.11	2.45	2.40	1.31	1.17	1.53	1.85	1.25	1.14	2.78	2.81
8800	1.75	2.72	1.66	1.70	1.12	1.21	2.46	2.35	1.37	1.15	1.57	1.86	1.12	1.14	2.78	2.84
9000	1.82	2.80	1.78	1.68	1.09	1.14	2.45	2.49	1.29	1.19	1.48	1.86	1.18	1.15	2.86	2.89
9200	1.72	2.80	1.76	1.67	1.09	1.12	2.48	2.38	1.37	1.12	1.47	1.94	1.27	1.25	2.92	2.95
9400	1.76	2.84	1.67	1.74	1.09	1.30	2.57	2.41	1.38	1.16	1.59	1.9	1.2	1.26	2.94	2.98
9600	1.76	2.81	1.78	1.75	1.05	1.14	2.57	2.42	1.32	1.21	1.59	1.9	1.17	1.17	3.02	2.96
9800	1.89	2.94	1.83	1.76	1.13	1.21	2.50	2.50	1.38	1.17	1.51	1.91	1.22	1.19	3.15	2.98
10000	1.82	2.86	1.71	1.74	1.07	1.19	2.65	2.51	1.33	1.22	1.59	1.86	1.23	1.29	3.1	3.04

10400	1.93	2.88	1.82	1.85	1.08	1.33	2.64	2.48	1.38	1.21	1.61	1.91	1.22	1.31	3.27	3.08
10800	1.92	3.01	1.73	1.75	1.13	1.25	2.73	2.57	1.37	1.23	1.57	1.99	1.34	1.37	3.28	3.19
11200	1.94	2.94	1.86	1.77	1.15	1.22	2.73	2.62	1.35	1.24	1.62	1.93	1.28	1.35	3.5	3.24
11600	2.06	2.96	1.90	1.84	1.16	1.33	2.76	2.68	1.37	1.22	1.56	1.95	1.32	1.27	3.49	3.34
12000	2.11	2.94	1.89	1.85	1.07	1.40	2.82	2.64	1.42	1.22	1.55	2.01	1.35	1.38	3.58	3.39
12400	2.10	3.09	1.78	1.82	1.15	1.25	2.85	2.66	1.4	1.2	1.62	2.01	1.21	1.4	3.79	3.55
12800	2.11	3.04	1.79	1.91	1.16	1.40	2.89	2.67	1.39	1.28	1.64	2.02	1.28	1.33	4.03	3.66
13200	2.12	3.05	1.90	1.93	1.13	1.30	2.95	2.76	1.4	1.23	1.67	2.02	1.27	1.44	4.14	3.72
13600	2.08	3.07	1.91	1.88	1.19	1.24	2.97	2.76	1.38	1.24	1.63	2.1	1.41	1.45	4.17	3.96
14000	2.17	3.17	1.94	1.90	1.18	1.35	3.07	2.72	1.42	1.25	1.62	2.07	1.25	1.43	4.27	4.13
14400	2.08	3.09	1.98	1.98	1.10	1.31	3.12	2.84	1.38	1.28	1.67	2.06	1.43	1.39	4.46	4.43
14800	2.23	3.14	1.99	1.95	1.10	1.26	3.09	2.80	1.45	1.31	1.73	2.05	1.36	1.38	4.63	4.69
15200	2.11	3.17	1.86	1.96	1.19	1.44	3.04	2.81	1.39	1.31	1.64	2.11	1.44	1.42	4.9	4.79
15600	2.15	3.17	1.96	2.02	1.20	1.38	3.20	2.92	1.44	1.31	1.67	2.12	1.29	1.44	5.28	5
16000	2.29	3.19	2.00	2.09	1.23	1.29	3.11	2.95	1.46	1.33	1.73	2.11	1.3	1.63	5.48	5.16
16400	2.19	3.22	1.99	2.06	1.20	1.38	3.33	2.95	1.43	1.28	1.76	2.14	1.46	1.56	5.33	5.33
16800	2.28	3.25	2.01	2.02	1.19	1.29	3.32	3.02	1.4	1.32	1.76	2.14	1.47	1.63	5.63	5.68
17200	2.35	3.24	2.01	2.10	1.12	1.32	3.39	2.97	1.41	1.29	1.7	2.18	1.46	1.5	5.85	5.83
17600	2.35	3.35	1.91	2.11	1.21	1.34	3.43	3.04	1.41	1.32	1.79	2.18	1.44	1.68	5.97	6.07
18000	2.35	3.24	2.05	2.15	1.20	1.49	3.51	3.05	1.45	1.3	1.78	2.2	1.39	1.58	6.74	6.26
18400	2.25	3.28	2.03	2.18	1.22	1.31	3.53	3.09	1.44	1.35	1.82	2.19	1.39	1.55	7.1	6.07
18800	2.39	3.35	2.05	2.12	1.22	1.43	3.47	3.10	1.5	1.37	1.77	2.22	1.34	1.65	7.15	6.31
19200	2.31	3.36	2.10	2.15	1.22	1.36	3.68	3.06	1.42	1.32	1.74	2.19	1.45	1.58	7.97	6.35
19600	2.32	3.45	2.12	2.26	1.22	1.53	3.66	3.13	1.47	1.3	1.79	2.2	1.5	1.72	7.78	6.53
20000	2.44	3.35	2.11	2.33	1.23	1.53	3.60	3.17	1.41	1.35	1.85	2.21	1.55	1.61	8.09	6.73

HWTB Results Mixture 3 and 4 (mm)

Number of Wheel Passes	Mixture 3										Mixture 4							
	Temperature										Temperature							
	50	50	50	50	40	40	60	60	50	50	50	50	60	60	50	50	40	40
0	0.00	0.00	0.00	0.00	0.00	0.00	0.00	0.00	0.00	0.00	0.00	0.00	0.00	0.00	0.00	0.00	0.00	0.00
100	0.59	0.59	0.40	0.72	0.41	0.66	0.93	0.68	0.48	0.48	0.65	0.92	0.88	0.76	0.68	0.89	0.58	0.44
200	0.75	0.73	0.64	0.87	0.48	0.81	1.19	0.90	0.80	0.73	0.83	1.07	1.06	0.96	0.87	1.03	0.74	0.66
300	0.86	0.85	0.60	0.81	0.55	0.83	1.34	1.05	0.86	0.77	0.90	1.11	1.17	1.22	0.99	1.32	0.84	0.68
400	1.00	0.92	0.78	0.88	0.59	0.88	1.47	1.07	0.93	0.82	0.96	1.25	1.25	1.33	1.05	1.29	1.02	0.80
500	1.02	0.98	0.84	1.07	0.61	0.94	1.62	1.16	1.01	0.93	1.01	1.24	1.32	1.28	1.15	1.35	1.01	0.86
600	1.07	0.97	0.89	1.14	0.64	0.92	1.58	1.22	1.05	0.87	1.07	1.36	1.32	1.30	1.18	1.42	1.03	0.90
700	1.15	1.08	0.93	1.05	0.64	0.91	1.58	1.31	1.06	1.01	1.12	1.36	1.42	1.55	1.22	1.52	1.10	0.92

800	1.16	1.03	0.91	1.11	0.70	0.94	1.69	1.37	1.09	0.94	1.14	1.40	1.47	1.49	1.25	1.69	1.16	0.91
900	1.22	1.09	0.90	1.15	0.71	0.95	1.75	1.40	1.02	1.00	1.21	1.49	1.46	1.53	1.35	1.54	1.20	0.95
1000	1.20	1.14	0.93	1.22	0.74	1.02	1.81	1.47	1.16	1.03	1.20	1.48	1.54	1.60	1.33	1.57	1.31	1.06
1100	1.32	1.17	0.97	1.43	0.74	1.06	1.87	1.49	1.17	1.05	1.24	1.52	1.58	1.76	1.38	1.61	1.38	1.13
1200	1.31	1.26	1.01	1.33	0.74	1.03	1.90	1.56	1.19	1.11	1.28	1.56	1.56	1.88	1.41	1.75	1.46	1.12
1300	1.41	1.25	1.16	1.49	0.77	1.12	1.95	1.57	1.23	1.11	1.30	1.53	1.70	2.02	1.42	1.65	1.45	1.20
1400	1.41	1.27	1.06	1.51	0.76	1.12	1.98	1.64	1.32	1.15	1.32	1.54	1.69	1.92	1.46	1.89	1.37	1.26
1500	1.46	1.33	1.21	1.45	0.78	1.05	2.01	1.67	1.25	1.23	1.34	1.53	1.79	1.90	1.49	1.81	1.62	1.31
1600	1.46	1.29	1.24	1.55	0.80	1.08	2.01	1.70	1.35	1.27	1.37	1.61	1.78	2.02	1.54	1.76	1.39	1.28
1700	1.51	1.38	1.27	1.46	0.81	1.08	2.03	1.74	1.25	1.28	1.39	1.56	1.84	2.23	1.52	1.81	1.39	1.25
1800	1.46	1.30	1.16	1.60	0.83	1.16	2.07	1.75	1.31	1.23	1.41	1.58	1.80	2.24	1.55	1.98	1.43	1.29
1900	1.53	1.34	1.19	1.47	0.81	1.21	2.08	1.77	1.35	1.23	1.42	1.60	1.87	2.28	1.58	1.79	1.49	1.37
2000	1.54	1.34	1.20	1.51	0.87	1.24	2.13	1.76	1.37	1.36	1.43	1.66	1.91	2.26	1.60	2.01	1.43	1.37
2100	1.60	1.42	1.31	1.62	0.87	1.15	2.12	1.82	1.35	1.28	1.45	1.62	1.96	2.15	1.59	1.92	1.54	1.31
2200	1.54	1.48	1.24	1.54	0.85	1.31	2.11	1.78	1.49	1.38	1.46	1.62	1.97	2.42	1.65	1.88	1.50	1.42
2300	1.62	1.42	1.26	1.54	0.89	1.28	2.25	1.83	1.46	1.41	1.46	1.71	1.99	2.21	1.67	1.90	1.73	1.37
2400	1.66	1.49	1.28	1.69	0.89	1.19	2.25	1.82	1.54	1.35	1.44	1.65	1.96	2.47	1.61	1.91	1.64	1.46
2500	1.55	1.42	1.31	1.68	0.89	1.23	2.25	1.86	1.49	1.31	1.44	1.67	2.06	2.29	1.68	1.89	1.55	1.39
2600	1.66	1.46	1.40	1.72	0.92	1.25	2.25	1.87	1.56	1.33	1.47	1.70	2.00	2.25	1.64	1.89	1.55	1.48
2700	1.66	1.48	1.34	1.57	0.92	1.24	2.26	1.86	1.45	1.34	1.48	1.69	2.09	2.29	1.72	2.06	1.62	1.44
2800	1.74	1.50	1.36	1.62	0.93	1.30	2.31	1.89	1.50	1.50	1.47	1.74	2.12	2.35	1.71	1.97	1.54	1.44
2900	1.71	1.50	1.51	1.73	0.94	1.33	2.26	1.91	1.57	1.50	1.52	1.78	2.06	2.35	1.72	1.94	1.66	1.48
3000	1.75	1.56	1.54	1.72	0.94	1.28	2.37	1.94	1.59	1.43	1.62	1.84	2.15	2.34	1.73	1.94	1.59	1.50
3100	1.76	1.59	1.55	1.67	0.93	1.34	2.35	1.91	1.62	1.41	1.62	1.80	2.09	2.60	1.76	2.10	1.62	1.47
3200	1.80	1.52	1.43	1.63	0.95	1.34	2.36	1.95	1.65	1.56	1.65	1.82	2.12	2.37	1.79	2.02	1.61	1.45
3300	1.78	1.61	1.47	1.75	0.95	1.36	2.38	1.97	1.69	1.56	1.68	1.83	2.23	2.61	1.73	1.98	1.60	1.55
3400	1.77	1.54	1.45	1.76	0.98	1.38	2.35	2.05	1.57	1.54	1.67	1.81	2.13	2.70	1.77	2.13	1.89	1.46
3500	1.88	1.58	1.61	1.76	0.97	1.45	2.41	1.97	1.61	1.49	1.70	1.78	2.25	2.70	1.82	2.05	1.70	1.50
3600	1.80	1.60	1.50	1.76	0.99	1.44	2.40	2.01	1.64	1.61	1.74	1.79	2.26	2.72	1.80	2.16	1.65	1.56
3700	1.88	1.62	1.48	1.75	0.96	1.54	2.38	2.04	1.67	1.60	1.71	1.82	2.19	2.74	1.79	2.08	1.75	1.53
3800	1.88	1.66	1.51	1.65	0.99	1.58	2.40	2.06	1.65	1.50	1.75	1.79	2.31	2.57	1.78	2.18	1.64	1.49
3900	1.79	1.68	1.51	1.71	0.99	1.60	2.40	2.05	1.66	1.63	1.74	1.84	2.28	2.55	1.86	2.10	1.91	1.57
4000	1.94	1.69	1.53	1.79	0.97	1.59	2.54	2.08	1.66	1.54	1.74	1.87	2.24	2.62	1.86	2.05	1.71	1.55
4100	1.93	1.70	1.54	1.67	0.97	1.53	2.53	2.08	1.67	1.68	1.79	1.88	2.31	2.80	1.87	2.06	1.64	1.52
4200	1.91	1.74	1.57	1.81	1.02	1.67	2.53	2.12	1.65	1.59	1.77	1.86	2.34	2.83	1.83	2.07	1.79	1.52
4300	1.96	1.72	1.71	1.66	1.02	1.60	2.55	2.18	1.70	1.55	1.77	1.87	2.26	2.84	1.83	2.13	1.71	1.57
4400	1.96	1.67	1.57	1.80	1.01	1.67	2.55	2.17	1.69	1.72	1.78	1.88	2.37	2.90	1.85	2.28	1.89	1.53
4500	1.99	1.70	1.57	1.85	1.07	1.62	2.55	2.16	1.69	1.70	1.78	1.91	2.36	2.92	1.87	2.23	1.66	1.54
4600	1.95	1.69	1.70	1.68	1.02	1.72	2.56	2.19	1.78	1.64	1.81	1.93	2.37	2.95	1.92	2.10	1.75	1.53
4700	1.91	1.81	1.60	1.72	1.04	1.60	2.57	2.27	1.81	1.64	1.83	1.89	2.38	2.93	1.92	2.11	1.80	1.61
4800	1.97	1.74	1.62	1.85	1.05	1.64	2.59	2.22	1.84	1.77	1.83	1.88	2.40	2.89	1.91	2.13	1.81	1.57

4900	2.02	1.81	1.77	1.78	1.03	1.67	2.61	2.24	1.85	1.68	1.84	1.90	2.44	2.69	1.90	2.21	1.80	1.51
5000	1.97	1.84	1.63	1.78	1.04	1.71	2.63	2.28	1.86	1.64	1.83	1.89	2.43	2.76	1.93	2.27	1.75	1.60
5200	1.98	1.75	1.76	1.81	1.03	1.77	2.66	2.26	1.88	1.70	1.83	1.94	2.38	2.77	1.95	2.14	1.97	1.58
5400	2.05	1.79	1.67	1.90	1.05	1.81	2.71	2.32	1.88	1.73	1.84	1.97	2.39	2.83	1.98	2.35	1.92	1.53
5600	2.17	1.79	1.70	1.77	1.08	1.78	2.67	2.32	1.83	1.73	1.85	1.90	2.48	3.07	1.94	2.36	1.85	1.56
5800	2.12	1.88	1.88	1.94	1.14	1.86	2.72	2.42	1.90	1.86	1.87	1.90	2.50	3.12	1.99	2.37	1.76	1.58
6000	2.20	1.90	1.76	1.81	1.12	1.81	2.77	2.38	1.83	1.90	1.90	1.94	2.56	2.82	2.00	2.34	1.80	1.61
6200	2.22	1.90	1.77	1.99	1.14	1.86	2.76	2.42	1.95	1.77	1.88	1.90	2.54	2.90	2.02	2.26	1.92	1.57
6400	2.24	1.87	1.93	1.96	1.12	1.92	2.79	2.46	1.86	1.93	1.89	1.94	2.56	3.13	2.04	2.37	1.97	1.65
6600	2.23	1.89	1.79	1.85	1.14	1.85	2.81	2.48	1.99	1.91	1.90	1.91	2.51	3.18	2.02	2.33	1.79	1.58
6800	2.21	1.90	1.83	2.03	1.12	1.91	2.79	2.50	2.04	1.97	1.93	1.99	2.64	2.98	2.07	2.27	2.06	1.66
7000	2.30	1.90	2.00	1.87	1.14	1.93	2.85	2.51	1.92	1.88	1.94	1.91	2.54	2.92	2.07	2.27	2.03	1.59
7200	2.30	1.99	1.96	2.03	1.19	2.08	2.82	2.57	1.93	2.01	1.95	1.98	2.67	3.03	2.08	2.27	2.04	1.59
7400	2.25	1.93	1.87	1.89	1.13	2.10	2.84	2.52	2.10	1.93	1.94	1.98	2.58	3.28	2.06	2.42	1.89	1.60
7600	2.26	1.97	1.89	2.03	1.20	2.13	2.92	2.53	2.09	1.95	1.97	1.94	2.59	3.02	2.10	2.32	1.91	1.61
7800	2.26	2.01	2.01	2.03	1.14	2.11	2.95	2.66	2.13	2.08	1.98	1.98	2.68	3.09	2.12	2.32	2.04	1.62
8000	2.31	2.00	1.94	1.91	1.21	2.04	2.95	2.70	2.03	1.98	1.97	2.00	2.73	3.06	2.08	2.38	1.87	1.59
8200	2.36	2.01	1.95	2.07	1.17	2.16	2.91	2.64	2.07	1.97	1.98	2.04	2.71	3.35	2.14	2.51	1.99	1.61
8400	2.27	2.05	1.97	2.00	1.20	2.07	2.97	2.68	2.07	2.12	1.98	2.05	2.65	3.07	2.12	2.33	1.81	1.69
8600	2.42	2.04	1.99	1.93	1.22	2.16	2.98	2.71	2.13	2.03	1.99	2.06	2.71	3.39	2.18	2.34	1.94	1.65
8800	2.35	2.05	2.00	1.96	1.24	2.18	2.98	2.74	2.13	2.14	1.99	2.04	2.75	3.40	2.12	2.37	2.12	1.61
9000	2.34	2.06	2.02	2.10	1.19	2.10	3.03	2.76	2.26	2.19	2.02	2.01	2.79	3.10	2.17	2.43	1.86	1.67
9200	2.38	2.07	2.18	2.05	1.28	2.17	3.06	2.79	2.30	2.06	2.01	2.07	2.73	3.17	2.17	2.52	1.91	1.64
9400	2.44	2.09	2.20	2.10	1.29	2.24	3.04	2.88	2.36	2.19	2.05	1.99	2.85	3.14	2.18	2.41	1.93	1.67
9600	2.49	2.09	2.03	2.07	1.31	2.25	3.11	2.87	2.25	2.12	2.04	2.03	2.75	3.49	2.19	2.59	1.92	1.62
9800	2.50	2.14	2.04	2.00	1.31	2.13	3.14	2.86	2.24	2.09	2.05	2.02	2.84	3.19	2.21	2.45	1.96	1.68
10000	2.53	2.20	2.05	2.14	1.32	2.20	3.16	2.87	2.42	2.12	2.08	2.01	2.90	3.51	2.22	2.43	1.99	1.66
10400	2.53	2.17	2.08	2.11	1.38	2.26	3.16	2.89	2.44	2.19	2.07	2.04	2.87	3.23	2.20	2.47	1.95	1.72
10800	2.55	2.21	2.14	2.04	1.33	2.28	3.15	2.91	2.30	2.20	2.09	2.11	2.94	3.53	2.23	2.59	1.91	1.73
11200	2.57	2.19	2.15	2.21	1.44	2.31	3.26	2.93	2.53	2.21	2.11	2.09	2.97	3.29	2.25	2.52	1.95	1.70
11600	2.64	2.19	2.21	2.19	1.41	2.27	3.30	3.03	2.37	2.25	2.13	2.07	2.91	3.39	2.32	2.51	1.88	1.67
12000	2.63	2.25	2.23	2.06	1.38	2.26	3.35	3.02	2.48	2.41	2.17	2.13	3.01	3.69	2.29	2.64	2.00	1.67
12400	2.68	2.36	2.27	2.23	1.48	2.26	3.33	3.09	2.47	2.48	2.18	2.08	3.08	3.47	2.28	2.72	1.97	1.71
12800	2.59	2.33	2.45	2.11	1.47	2.27	3.29	3.18	2.75	2.50	2.20	2.10	3.07	3.41	2.34	2.72	1.92	1.69
13200	2.66	2.33	2.47	2.26	1.42	2.37	3.36	3.18	2.62	2.54	2.20	2.12	3.02	3.48	2.37	2.61	2.00	1.68
13600	2.64	2.36	2.50	2.13	1.45	2.31	3.40	3.27	2.67	2.51	2.21	2.08	3.05	3.82	2.35	2.57	1.97	1.77
14000	2.76	2.36	2.37	2.27	1.51	2.40	3.46	3.36	2.63	2.43	2.21	2.11	3.17	3.59	2.35	2.57	1.95	1.75
14400	2.70	2.36	2.34	2.27	1.51	2.39	3.56	3.39	2.89	2.45	2.24	2.16	3.19	3.59	2.39	2.73	1.94	1.73
14800	2.81	2.38	2.41	2.17	1.58	2.35	3.60	3.33	2.94	2.58	2.26	2.14	3.21	3.91	2.37	2.74	2.04	1.71
15200	2.76	2.40	2.37	2.29	1.50	2.36	3.64	3.29	3.00	2.50	2.25	2.20	3.16	3.93	2.41	2.66	1.98	1.74
15600	2.82	2.42	2.46	2.17	1.59	2.37	3.68	3.31	2.86	2.57	2.27	2.13	3.21	3.62	2.44	2.77	1.95	1.78

16000	2.83	2.43	2.47	2.34	1.59	2.37	3.66	3.41	2.85	2.62	2.29	2.17	3.22	3.94	2.44	2.71	2.19	1.80
16400	2.80	2.48	2.50	2.30	1.56	2.48	3.64	3.35	2.99	2.76	2.28	2.21	3.29	3.65	2.45	2.81	1.96	1.80
16800	2.97	2.51	2.52	2.24	1.60	2.47	3.72	3.52	3.04	2.70	2.31	2.24	3.33	3.70	2.48	2.75	2.07	1.77
17200	2.90	2.51	2.47	2.36	1.56	2.49	3.82	3.43	3.09	2.84	2.33	2.20	3.34	4.05	2.44	2.88	2.13	1.74
17600	3.01	2.52	2.59	2.34	1.65	2.45	3.86	3.46	3.13	3.02	2.34	2.22	3.38	3.78	2.49	2.89	2.06	1.80
18000	2.96	2.61	2.62	2.27	1.67	2.55	3.89	3.62	3.17	3.00	2.34	2.20	3.32	4.11	2.47	2.80	2.27	1.83
18400	3.03	2.55	2.75	2.40	1.73	2.54	3.82	3.52	3.35	3.06	2.36	2.19	3.43	4.13	2.48	2.77	2.08	1.77
18800	3.11	2.65	2.61	2.43	1.72	2.53	3.95	3.57	3.41	3.19	2.34	2.26	3.45	3.83	2.51	2.83	2.04	1.84
19200	3.11	2.57	2.63	2.27	1.77	2.50	3.94	3.64	3.44	3.17	2.37	2.24	3.48	3.78	2.54	2.86	2.05	1.77
19600	3.14	2.62	2.81	2.52	1.73	2.52	4.02	3.76	3.32	3.19	2.36	2.25	3.49	3.88	2.58	2.82	2.08	1.82
20000	3.16	2.70	2.72	2.40	1.67	2.56	4.02	3.78	3.22	3.28	2.36	2.26	3.59	3.94	2.57	2.86	2.04	1.80

HWTD Results Mixture 5 and 6 (mm)

Number of Wheel Passes	Mixture 5								Mixture 6							
	Temperature								Temperature							
	50	50	50	40	40	60	60	50	50	60	60	50	50	40	40	
0	0.00	0.00	0.00	0.00	0.00	0.00	0.00	0.00	0.00	0.00	0.00	0.00	0.00	0.00	0.00	
100	0.37	0.43	0.59	0.57	0.48	0.75	0.92	0.94	0.86	1.09	0.97	0.86	0.77	0.45	0.5	
200	0.47	0.54	0.72	0.69	0.52	0.98	1.15	1.29	1.14	1.44	1.3	1.53	1.02	0.64	0.55	
300	0.51	0.63	0.81	0.74	0.54	1.13	1.36	1.47	1.33	1.62	1.55	1.82	1.26	0.64	0.75	
400	0.56	0.60	0.84	0.75	0.57	1.25	1.55	1.62	1.57	1.81	1.89	1.93	1.37	0.71	0.7	
500	0.60	0.63	0.86	0.77	0.62	1.36	1.68	1.81	1.62	2	2.06	2.17	1.51	0.8	0.85	
600	0.61	0.76	0.95	0.79	0.61	1.46	1.84	1.9	1.86	2.13	2.11	2.74	1.59	0.92	0.8	
700	0.69	0.76	0.93	0.81	0.70	1.55	1.99	2.04	1.86	2.26	2.31	2.64	1.68	0.86	0.96	
800	0.74	0.71	0.99	0.81	0.62	1.68	2.11	2.15	1.93	2.37	2.46	2.83	1.78	0.96	0.98	
900	0.78	0.82	1.06	0.82	0.75	1.81	2.40	2.21	2.28	2.55	2.53	2.85	1.98	0.95	0.97	
1000	0.73	0.83	1.05	0.88	0.72	1.85	2.43	2.39	2.11	2.68	2.61	3.04	1.97	1.05	0.98	
1100	0.72	0.79	1.08	0.87	0.68	1.95	2.59	2.4	2.33	2.8	2.82	2.92	2.05	1.04	1.12	
1200	0.84	0.86	1.14	0.86	0.71	1.96	2.77	2.47	2.27	2.98	2.98	3.28	2.16	1.14	1.12	
1300	0.85	0.87	1.11	0.89	0.64	2.03	2.90	2.53	2.43	3.17	3	3.32	2.16	1.18	1.13	
1400	0.87	0.84	1.13	0.90	0.68	2.15	3.04	2.57	2.55	3.36	3.15	3.43	2.23	1.21	1.1	
1500	0.89	0.84	1.17	0.89	0.72	2.14	3.16	2.62	2.56	3.67	3.31	3.29	2.27	1.2	1.16	
1600	0.92	0.94	1.17	0.86	0.76	2.33	3.15	2.76	2.51	3.78	3.44	3.48	2.33	1.17	1.11	
1700	0.93	0.92	1.17	0.92	0.70	2.46	3.47	2.72	2.73	4.04	3.57	3.46	2.42	1.25	1.15	
1800	0.96	0.84	1.22	0.91	0.73	2.51	3.52	2.82	2.91	4.45	3.75	3.79	2.46	1.24	1.15	
1900	0.94	0.96	1.22	0.92	0.75	2.51	3.75	2.81	2.97	4.7	3.88	3.85	2.56	1.25	1.24	
2000	0.99	0.88	1.25	0.91	0.77	2.63	3.91	2.89	3.04	5.04	4.02	3.94	2.5	1.27	1.31	
2100	0.91	0.97	1.27	0.94	0.74	2.73	4.07	2.95	3.09	5.43	4.23	3.99	2.62	1.37	1.29	
2200	0.98	0.99	1.28	0.97	0.77	2.69	4.18	3.09	3.12	5.8	4.35	3.78	2.57	1.35	1.34	
2300	0.97	0.92	1.31	0.96	0.78	2.75	4.21	3.17	3.06	6.26	4.58	4.03	2.73	1.26	1.34	

2400	0.98	1.04	1.35	0.94	0.81	2.82	4.61	3.06	3.08	6.68	4.79	3.92	2.74	1.39	1.34
2500	1.02	0.97	1.40	0.94	0.79	3.01	4.76	3.12	2.97	7.07	4.89	4.26	2.8	1.39	1.27
2600	1.01	1.05	1.36	0.97	0.85	3.02	4.97	3.14	2.98	7.59	5.17	4.34	2.78	1.33	1.3
2700	1.08	1.06	1.36	1.00	0.78	3.02	5.16	3.19	3.36	7.78	5.24	4.48	2.88	1.46	1.32
2800	1.04	0.98	1.38	0.98	0.79	3.18	5.25	3.2	3.08	8.05	5.51	4.6	2.88	1.44	1.35
2900	1.10	1.07	1.39	1.00	0.83	3.16	5.54	3.39	3.35	8.52	5.58	4.41	2.88	1.42	1.34
3000	1.08	0.98	1.41	0.98	0.88	3.17	5.75	3.3	3.3	9.09	5.87	4.72	2.93	1.39	1.46
3100	0.98	1.10	1.42	1.01	0.81	3.39	5.99	3.49	3.22	9.68	5.95	4.66	2.95	1.4	1.52
3200	1.05	1.10	1.43	0.98	0.82	3.55	6.42	3.38	3.29	10	6.17	4.67	3.04	1.41	1.41
3300	1.11	1.01	1.43	1.04	0.83	3.65	6.72	3.57	3.53	10.1	6.36	5.01	3.03	1.58	1.54
3400	1.11	1.01	1.45	1.02	0.84	3.74	6.85	3.44	3.71	10.4	6.52	4.88	3.09	1.55	1.41
3500	1.14	1.03	1.43	1.01	0.87	3.75	6.97	3.61	3.76	10.8	6.83	4.93	3.18	1.46	1.49
3600	1.08	1.13	1.46	1.04	0.85	3.66	7.37	3.7	3.8	11.3	7.07	5.02	3.35	1.63	1.53
3700	1.16	1.14	1.43	1.00	0.82	3.84	7.71	3.57	3.83	11.4	7.14	5.44	3.44	1.48	1.54
3800	1.14	1.04	1.53	1.04	0.87	4.17	7.56	3.56	3.72	11.5	7.55	5.54	3.41	1.62	1.58
3900	1.16	1.11	1.54	1.01	0.86	4.14	8.26	3.62	3.53	12	7.62	5.68	3.35	1.68	1.59
4000	1.13	1.13	1.55	1.01	0.85	4.16	8.44	3.63	3.71	12.7	8	5.47	3.53	1.62	1.59
4100	1.16	1.05	1.49	1.03	0.82	4.41	8.50	3.69	4	13.2	8.29	5.57	3.44	1.53	1.64
4200	1.11	1.07	1.54	1.03	0.86	4.75	8.83	3.77	3.88	12.6	8.34	5.79	3.6	1.61	1.54
4300	1.15	1.06	1.54	1.02	0.82	4.34	9.04	3.81	3.68	14.1	8.58	6.1	3.62	1.63	1.64
4400	1.17	1.07	1.61	1.05	0.85	4.98	9.40	3.86	3.87	14.4	8.84	5.87	3.52	1.76	1.59
4500	1.19	1.10	1.58	1.05	0.81	5.16	9.80	4	4.19	14.6	9.15	6.04	3.81	1.72	1.67
4600	1.24	1.17	1.59	1.09	0.88	4.85	10.03	4.02	4.02	14.9	9.7	6.21	3.82	1.62	1.59
4700	1.22	1.22	1.60	1.03	0.83	5.46	10.43	4.06	3.84	15.2	9.89	6.28	3.69	1.68	1.71
4800	1.12	1.11	1.61	1.03	0.90	5.30	10.89	4.11	4.22	15.8	10.3	6.48	3.91	1.74	1.74
4900	1.24	1.12	1.62	1.05	0.93	5.19	10.69	4.03	4.16	16.4	10.6	6.89	3.91	1.73	1.85
5000	1.17	1.13	1.68	1.05	0.82	6.19	12.37	4.07	3.97	16.6	11.1	6.68	3.73	1.83	1.75
5200	1.28	1.23	1.66	1.09	0.90	5.76	12.14	4.11	4.43	17.5	11.6	6.97	4.03	1.86	1.9
5400	1.24	1.26	1.68	1.05	0.87	6.83	13.60	4.13	4.41	17.9	12.8	7.43	4.13	1.79	1.89
5600	1.24	1.14	1.67	1.07	0.88	7.39	13.55	4.28	4.41	18.3	13.3	7.89	4.26	1.88	1.93
5800	1.23	1.24	1.71	1.07	0.85	7.89	15.03	4.36	4.33	N/A	13.4	8.25	4.23	2	2.01
6000	1.31	1.15	1.73	1.10	0.86	7.83	14.96	4.65	4.43	N/A	13.9	8.09	4.36	1.99	1.91
6200	1.29	1.16	1.68	1.08	0.95	8.11	16.31	4.54	5.05	N/A	14.1	8.79	4.49	1.91	2.04
6400	1.39	1.31	1.78	1.06	0.90	8.90	16.03	4.64	4.65	N/A	15.5	8.6	4.64	1.92	1.95
6600	1.34	1.32	1.86	1.09	0.92	7.37	17.83	4.94	4.78	N/A	16.2	8.92	4.66	1.99	2.01
6800	1.38	1.33	1.81	1.08	0.92	9.50	17.77	4.85	5.42	N/A	N/A	9.34	4.78	2.02	2.1
7000	1.34	1.34	1.82	1.08	0.92	9.33	N/A	5.24	5.03	N/A	N/A	9.59	4.97	1.98	1.99
7200	1.33	1.23	1.90	1.11	0.89	10.77	N/A	5.35	5.16	N/A	N/A	9.79	5.11	2.19	2.14
7400	1.43	1.37	1.84	1.09	1.00	9.59	N/A	5.51	5.84	N/A	N/A	10.1	5.1	2.02	2.1
7600	1.38	1.38	1.85	1.13	0.92	11.33	N/A	5.42	5.44	N/A	N/A	10.7	5.24	2.03	2.04
7800	1.41	1.26	1.93	1.13	0.96	11.93	N/A	5.57	6.16	N/A	N/A	10.7	5.36	2.11	2.09

8000	1.41	1.27	1.96	1.14	0.90	12.47	N/A	5.69	6.06	N/A	N/A	11.3	5.53	2.27	2.11
8200	1.40	1.43	1.97	1.14	0.95	12.18	N/A	6.11	6.15	N/A	N/A	12	5.77	2.12	2.11
8400	1.41	1.40	1.97	1.11	0.92	12.74	N/A	6	6.49	N/A	N/A	12.5	6.05	2.24	2.26
8600	1.42	1.46	1.86	1.16	1.00	14.16	N/A	6.47	6.59	N/A	N/A	12.6	5.93	2.17	2.21
8800	1.36	1.34	1.95	1.15	1.01	13.70	N/A	6.61	6.58	N/A	N/A	13	6.54	2.24	2.32
9000	1.49	1.48	2.04	1.14	0.99	14.56	N/A	6.44	6.75	N/A	N/A	13.9	6.66	2.35	2.33
9200	1.51	1.44	1.94	1.17	0.99	14.65	N/A	6.34	6.96	N/A	N/A	14.1	7.15	2.22	2.32
9400	1.47	1.53	2.01	1.17	0.98	15.33	N/A	6.89	7.22	N/A	N/A	14.7	7.41	2.38	2.23
9600	1.49	1.39	2.03	1.15	0.99	16.18	N/A	7.39	7.95	N/A	N/A	15	7.72	2.33	2.36
9800	1.40	1.40	2.05	1.13	0.98	15.80	N/A	7.59	8.38	N/A	N/A	15	7.9	2.42	2.25
10000	1.51	1.50	2.02	1.18	1.03	N/A	N/A	7.8	8.16	N/A	N/A	N/A	7.7	2.4	2.36
10400	1.53	1.52	2.09	1.16	0.97	N/A	N/A	7.49	8.62	N/A	N/A	N/A	8.52	2.41	2.38
10800	1.51	1.62	2.12	1.17	1.03	N/A	N/A	8.17	9.14	N/A	N/A	N/A	9.67	2.63	2.35
11200	1.47	1.64	2.16	1.15	0.98	N/A	N/A	8.65	10.5	N/A	N/A	N/A	10.1	2.62	2.53
11600	1.55	1.78	2.14	1.17	1.00	N/A	N/A	9.82	11	N/A	N/A	N/A	10.3	2.52	2.44
12000	1.60	1.70	2.13	1.18	1.06	N/A	N/A	10.4	11.2	N/A	N/A	N/A	11.3	2.68	2.44
12400	1.53	1.86	2.24	1.21	1.05	N/A	N/A	10.2	12.2	N/A	N/A	N/A	11.3	2.67	2.59
12800	1.59	1.92	2.27	1.20	1.04	N/A	N/A	10.8	13.6	N/A	N/A	N/A	12.6	2.74	2.61
13200	1.65	1.92	2.36	1.21	1.07	N/A	N/A	12.5	15.2	N/A	N/A	N/A	13.1	2.87	2.62
13600	1.69	1.95	2.35	1.22	1.07	N/A	N/A	13.7	16.4	N/A	N/A	N/A	13.1	2.99	2.57
14000	1.67	1.98	2.37	1.20	1.04	N/A	N/A	14.2	N/A	N/A	N/A	N/A	14.3	3.1	2.72
14400	1.59	2.00	2.42	1.23	1.02	N/A	N/A	14.3	N/A	N/A	N/A	N/A	14.9	3.01	2.75
14800	1.66	1.99	2.43	1.24	1.11	N/A	N/A	16.5	N/A	N/A	N/A	N/A	14.9	3.15	2.74
15200	1.71	2.04	2.51	1.20	1.03	N/A	N/A	N/A	N/A	N/A	N/A	N/A	15.5	3.29	2.74
15600	1.79	2.06	2.40	1.20	1.09	N/A	N/A	N/A	N/A	N/A	N/A	N/A	16.6	3.23	2.85
16000	1.74	2.04	2.51	1.20	1.02	N/A	N/A	N/A	N/A	N/A	N/A	N/A	16.4	3.38	2.8
16400	1.77	2.10	2.50	1.22	1.06	N/A	N/A	N/A	N/A	N/A	N/A	N/A	16.9	3.45	2.86
16800	1.70	2.04	2.58	1.20	1.07	N/A	N/A	N/A	N/A	N/A	N/A	N/A	17.8	3.44	2.93
17200	1.75	2.12	2.60	1.20	1.14	N/A	N/A	N/A	N/A	N/A	N/A	N/A	N/A	3.54	3.03
17600	1.80	2.23	2.65	1.19	1.16	N/A	N/A	N/A	N/A	N/A	N/A	N/A	N/A	3.65	2.96
18000	1.81	2.36	2.70	1.22	1.18	N/A	N/A	N/A	N/A	N/A	N/A	N/A	N/A	3.73	2.89
18400	1.88	2.35	2.68	1.21	1.09	N/A	N/A	N/A	N/A	N/A	N/A	N/A	N/A	3.84	3.1
18800	1.85	2.24	2.69	1.23	1.07	N/A	N/A	N/A	N/A	N/A	N/A	N/A	N/A	3.87	3.02
19200	1.86	2.14	2.71	1.20	1.11	N/A	N/A	N/A	N/A	N/A	N/A	N/A	N/A	3.93	2.98
19600	1.89	2.37	2.77	1.24	1.10	N/A	N/A	N/A	N/A	N/A	N/A	N/A	N/A	4.02	3.07
20000	1.94	2.09	2.86	1.24	1.14	N/A	N/A	N/A	N/A	N/A	N/A	N/A	N/A	4.1	3.14

HWTD Results Mixture 7, 8, 9, 10, 11 and 12 (mm)

Number of Wheel Passes	Mixture 7							Mixture 8	Mixture 9	Mixture 10	Mixture 11	Mixture 12					
	Temperature							Temperature									
	50	50	40	50	50	60	60	50	50	50	50	50	50				
0	0.00	0.00	0.00	0.00	0.00	0.00	0.00	0	0	0	0	0	0	0	0	0	0
100	0.65	0.72	0.37	0.66	0.82	1.10	1.14	0.61	0.68	0.57	0.61	1	1.36	0.63	0.5	0.38	0.44
200	0.83	1.04	0.49	0.79	1.01	1.39	1.48	0.8	0.92	0.78	0.79	1.14	1.43	0.85	0.74	0.49	0.5
300	0.99	1.24	0.57	0.95	1.20	1.65	1.64	0.95	1.02	0.96	0.92	1.24	1.56	0.96	0.74	0.52	0.65
400	1.09	1.26	0.62	1.03	1.20	1.88	1.92	1	1.15	1.07	1.04	1.41	1.65	1.05	0.9	0.61	0.68
500	1.14	1.33	0.67	1.11	1.31	2.06	2.10	1.09	1.27	1.14	1.12	1.44	1.67	1.13	0.87	0.63	0.76
600	1.13	1.51	0.69	1.21	1.35	2.22	2.11	1.2	1.31	1.19	1.24	1.56	1.79	1.13	0.96	0.7	0.75
700	1.22	1.56	0.83	1.25	1.40	2.36	2.24	1.26	1.39	1.33	1.34	1.53	1.83	1.18	1.05	0.72	0.82
800	1.28	1.76	0.78	1.32	1.46	2.63	2.60	1.28	1.39	1.34	1.42	1.59	1.81	1.24	0.99	0.72	0.83
900	1.30	1.74	0.91	1.39	1.51	2.73	2.62	1.37	1.46	1.46	1.53	1.64	1.93	1.28	1.05	0.75	0.84
1000	1.42	1.73	0.96	1.43	1.58	3.02	2.71	1.42	1.54	1.56	1.56	1.83	2.11	1.31	1.1	0.81	0.9
1100	1.40	1.78	0.91	1.49	1.71	3.13	2.85	1.42	1.56	1.57	1.62	1.89	2.13	1.48	1.13	0.81	0.94
1200	1.44	1.92	0.92	1.54	1.66	3.43	3.00	1.45	1.59	1.64	1.63	2.03	2.29	1.38	1.17	0.85	0.95
1300	1.54	1.97	1.03	1.54	1.76	3.58	3.15	1.5	1.63	1.67	1.67	2.01	2.3	1.43	1.19	0.89	1
1400	1.52	2.17	1.05	1.66	1.75	3.89	3.33	1.52	1.59	1.75	1.74	2.13	2.24	1.46	1.22	0.89	1.01
1500	1.63	2.01	1.04	1.63	1.80	4.27	3.56	1.61	1.72	1.7	1.7	2.09	2.32	1.48	1.22	0.89	1.04
1600	1.63	2.21	1.06	1.69	1.85	4.70	3.82	1.6	1.75	1.69	1.71	2.23	2.39	1.58	1.25	0.9	1.05
1700	1.62	2.13	1.06	1.74	1.98	5.07	4.22	1.62	1.67	1.8	1.78	2.19	2.44	1.63	1.31	0.95	1.09
1800	1.69	2.24	1.15	1.78	1.90	5.39	4.34	1.71	1.76	1.83	1.83	2.32	2.46	1.56	1.26	0.94	1.08
1900	1.72	2.29	1.18	1.88	2.02	6.09	4.77	1.72	1.79	1.88	1.85	2.34	2.47	1.67	1.3	0.93	1.11
2000	1.70	2.44	1.18	1.94	1.94	6.86	5.38	1.71	1.78	1.93	1.89	2.31	2.54	1.6	1.39	0.99	1.11
2100	1.79	2.40	1.18	1.96	1.99	7.51	5.94	1.74	1.95	1.99	1.93	2.45	2.52	1.77	1.47	0.99	1.15
2200	1.76	2.52	1.11	1.96	2.01	8.60	6.51	1.75	1.87	2.01	1.93	2.45	2.63	1.64	1.45	1.02	1.17
2300	1.84	2.53	1.23	2.02	2.13	9.23	6.95	1.82	2.05	2.08	1.99	2.41	2.53	1.72	1.52	1.05	1.18
2400	1.88	2.55	1.14	2.06	2.20	9.85	7.46	1.78	2	2.12	1.99	2.45	2.65	1.77	1.55	1.01	1.18
2500	1.85	2.77	1.23	2.12	2.12	10.42	8.11	1.85	2.04	2.15	2.04	2.54	2.69	1.69	1.56	1.02	1.2
2600	1.84	2.67	1.20	2.21	2.29	8.48	8.66	1.8	2.06	2.1	2.05	2.5	2.63	1.71	1.51	1.04	1.2
2700	1.90	2.70	1.19	2.29	2.20	10.51	8.96	1.9	2.08	2.22	2.1	2.62	2.72	1.81	1.51	1.06	1.24
2800	1.91	2.76	1.20	2.35	2.38	11.42	9.63	1.93	2.16	2.25	2.12	2.67	2.73	1.9	1.53	1.08	1.21
2900	1.94	2.82	1.21	2.34	2.39	10.76	10.36	1.95	2.02	2.26	2.15	2.7	2.67	1.86	1.56	1.1	1.25
3000	1.96	2.85	1.30	2.46	2.31	12.04	9.98	1.97	2.14	2.24	2.17	2.73	2.78	1.87	1.66	1.11	1.23
3100	2.00	2.95	1.28	2.45	2.38	13.14	10.64	1.99	2.19	2.35	2.18	2.67	2.87	1.8	1.66	1.15	1.32
3200	2.13	3.06	1.22	2.59	2.44	13.83	11.02	1.96	2.21	2.35	2.21	2.76	2.88	1.92	1.67	1.13	1.24
3300	2.10	3.03	1.33	2.63	2.56	14.63	10.91	1.94	2.11	2.39	2.25	2.77	2.82	1.88	1.65	1.13	1.3
3400	2.10	3.05	1.24	2.64	2.60	15.44	10.25	2.01	2.25	2.42	2.27	2.81	2.83	1.95	1.67	1.15	1.3
3500	2.19	3.25	1.35	2.80	2.53	16.06	11.45	2.03	2.31	2.35	2.29	2.75	2.87	1.96	1.75	1.16	1.28

3600	2.17	3.36	1.25	2.87	2.55	16.41	11.42	2.11	2.18	2.44	2.3	2.75	2.84	1.88	1.84	1.17	1.35
3700	2.25	3.48	1.34	2.95	2.73	18.02	12.20	2.08	2.32	2.48	2.33	2.83	2.94	2.05	1.79	1.17	1.33
3800	2.32	3.50	1.38	3.03	2.80	18.45	12.44	2.1	2.24	2.52	2.36	2.76	2.98	1.92	1.76	1.18	1.38
3900	2.29	3.51	1.31	3.11	2.63	18.91	12.48	2.12	2.34	2.5	2.39	2.89	2.88	2	1.78	1.19	1.37
4000	2.32	3.41	1.28	3.12	2.89	N/A	13.06	2.14	2.39	2.53	2.4	2.91	3.02	2.1	1.85	1.19	1.41
4100	2.40	3.32	1.30	3.32	2.96	N/A	12.36	2.13	2.39	2.58	2.42	2.85	3.09	1.95	1.87	1.24	1.4
4200	2.46	3.41	1.31	3.39	2.87	N/A	12.76	2.15	2.4	2.58	2.43	2.96	3.13	1.96	1.96	1.23	1.42
4300	2.49	3.74	1.32	3.45	2.91	N/A	12.66	2.19	2.28	2.59	2.48	2.97	3.11	2.04	1.91	1.21	1.4
4400	2.46	3.68	1.32	3.50	2.94	N/A	13.01	2.27	2.43	2.61	2.5	3	3.04	2.15	1.87	1.23	1.42
4500	2.52	3.83	1.33	3.58	3.12	N/A	13.28	2.23	2.44	2.64	2.51	3	3.14	2.12	1.91	1.29	1.48
4600	2.59	3.59	1.39	3.65	3.17	N/A	13.75	2.3	2.46	2.56	2.52	3.06	3.05	2.02	1.93	1.24	1.41
4700	2.64	3.78	1.40	3.82	3.19	N/A	N/A	2.22	2.48	2.64	2.55	3.05	3.08	2.03	2	1.27	1.45
4800	2.70	4.11	1.47	3.91	3.02	N/A	N/A	2.32	2.53	2.66	2.55	3.07	3.08	2.21	2.02	1.26	1.47
4900	2.70	3.86	1.54	4.00	3.34	N/A	N/A	2.35	2.51	2.66	2.58	3.09	3.21	2.07	2.05	1.32	1.48
5000	2.76	3.78	1.52	4.12	3.17	N/A	N/A	2.3	2.42	2.69	2.55	3.1	3.15	2.17	2	1.3	1.49
5200	2.83	3.98	1.48	4.31	3.52	N/A	N/A	2.38	2.57	2.69	2.63	3.11	3.2	2.2	2	1.34	1.48
5400	2.90	4.29	1.46	4.49	3.69	N/A	N/A	2.34	2.61	2.77	2.6	3.16	3.22	2.23	2.11	1.34	1.52
5600	2.96	4.39	1.48	4.75	3.70	N/A	N/A	2.42	2.52	2.78	2.65	3.07	3.18	2.32	2.16	1.41	1.57
5800	3.06	4.40	1.56	4.96	3.90	N/A	N/A	2.41	2.69	2.79	2.69	3.07	3.28	2.27	2.14	1.36	1.58
6000	3.12	4.51	1.60	5.37	4.10	N/A	N/A	2.49	2.74	2.82	2.74	3.18	3.2	2.2	2.18	1.39	1.63
6200	3.18	4.75	1.56	5.79	4.23	N/A	N/A	2.4	2.79	2.84	2.72	3.2	3.3	2.35	2.3	1.41	1.57
6400	3.26	4.56	1.55	6.15	4.41	N/A	N/A	2.5	2.81	2.89	2.82	3.26	3.35	2.29	2.29	1.43	1.63
6600	3.22	4.87	1.61	6.52	4.61	N/A	N/A	2.47	2.85	2.92	2.82	3.14	3.39	2.4	2.28	1.42	1.66
6800	3.44	4.76	1.53	6.86	4.80	N/A	N/A	2.53	2.86	2.95	2.79	3.29	3.39	2.37	2.39	1.45	1.67
7000	3.50	5.38	1.63	7.28	5.01	N/A	N/A	2.49	2.94	2.95	2.86	3.32	3.46	2.33	2.5	1.51	1.69
7200	3.62	5.07	1.60	7.82	5.25	N/A	N/A	2.58	2.97	2.97	2.9	3.22	3.46	2.5	2.57	1.47	1.68
7400	3.74	5.58	1.57	8.27	5.45	N/A	N/A	2.52	3.01	2.91	2.91	3.34	3.45	2.36	2.52	1.52	1.66
7600	3.81	5.54	1.58	8.62	5.38	N/A	N/A	2.49	3.07	3.02	2.88	3.35	3.41	2.51	2.54	1.53	1.78
7800	3.87	6.04	1.60	9.10	6.02	N/A	N/A	2.58	2.99	3.03	2.99	3.38	3.46	2.54	2.71	1.53	1.76
8000	4.02	6.12	1.68	9.33	5.82	N/A	N/A	2.59	3.16	3.08	2.98	3.28	3.45	2.42	2.58	1.55	1.73
8200	4.14	5.77	1.61	9.57	5.98	N/A	N/A	2.56	3.06	3.05	3.05	3.44	3.56	2.58	2.75	1.6	1.82
8400	4.12	6.38	1.61	9.87	6.35	N/A	N/A	2.64	3.1	3.08	3.03	3.46	3.5	2.58	2.78	1.55	1.77
8600	4.36	6.51	1.67	10.28	6.76	N/A	N/A	2.63	3.14	3.05	3.12	3.47	3.53	2.6	2.71	1.56	1.83
8800	4.35	6.20	1.75	10.95	7.08	N/A	N/A	2.6	3.34	3.16	3.07	3.49	3.62	2.6	2.73	1.56	1.85
9000	4.48	7.36	1.76	11.46	7.38	N/A	N/A	2.61	3.4	3.17	3.13	3.43	3.63	2.62	2.88	1.6	1.88
9200	4.56	7.35	1.77	10.45	7.71	N/A	N/A	2.6	3.43	3.15	3.21	3.53	3.58	2.63	2.95	1.64	1.89
9400	4.72	7.41	1.76	11.79	8.08	N/A	N/A	2.67	3.47	3.1	3.22	3.43	3.55	2.76	2.94	1.62	1.87
9600	4.79	7.63	1.77	12.66	8.46	N/A	N/A	2.76	3.45	3.19	3.2	3.57	3.7	2.79	2.84	1.68	1.87
9800	5.03	8.30	1.69	12.76	8.55	N/A	N/A	2.72	3.59	3.2	3.28	3.58	3.65	2.74	2.88	1.64	1.88
10000	5.05	8.10	1.79	13.55	9.34	N/A	N/A	2.8	3.53	3.22	3.32	3.53	3.59	2.7	2.9	1.69	1.99
10400	5.14	8.57	1.81	14.47	10.11	N/A	N/A	2.8	3.66	3.31	3.41	3.64	3.73	2.81	2.91	1.69	1.95

10800	5.49	9.10	1.78	15.20	10.65	N/A	N/A	2.92	3.76	3.24	3.41	3.67	3.72	2.91	3.1	1.7	1.96
11200	5.86	9.96	1.76	15.62	11.50	N/A	N/A	2.99	3.87	3.37	3.58	3.59	3.69	2.91	3	1.69	1.96
11600	6.39	9.95	1.88	16.35	11.84	N/A	N/A	2.97	3.95	3.39	3.62	3.67	3.71	2.87	3.21	1.72	2.1
12000	6.89	10.19	1.94	16.46	12.49	N/A	N/A	3.05	4.01	3.54	3.72	3.79	3.72	2.97	3.31	1.76	2.07
12400	6.92	11.66	1.93	17.29	13.18	N/A	N/A	3.08	3.9	3.49	3.78	3.8	3.87	2.85	3.33	1.75	2.1
12800	7.19	12.16	1.90	17.47	13.39	N/A	N/A	3.2	4.11	3.63	3.85	3.81	3.85	2.89	3.34	1.79	2.12
13200	7.91	13.19	1.98	N/A	14.78	N/A	N/A	3.12	4.01	3.65	3.92	3.78	3.88	3.01	3.37	1.82	2.06
13600	8.40	12.91	1.89	N/A	15.96	N/A	N/A	3.29	4.09	3.67	3.97	3.95	4.05	2.98	3.46	1.85	2.12
14000	8.83	14.65	1.98	N/A	17.30	N/A	N/A	3.35	4.29	3.76	4.04	3.86	4.11	3.05	3.45	1.84	2.15
14400	9.31	14.83	2.01	N/A	17.95	N/A	N/A	3.23	4.49	3.77	4.07	4.03	4.19	3.12	3.31	1.89	2.15
14800	9.87	14.84	2.09	N/A	N/A	N/A	N/A	3.32	4.36	3.76	4.13	4.08	4.14	3.15	3.53	1.88	2.18
15200	9.86	15.52	2.07	N/A	N/A	N/A	N/A	3.26	4.64	3.91	4.25	4	4.16	3.23	3.55	1.91	2.26
15600	9.97	N/A	2.04	N/A	N/A	N/A	N/A	3.25	4.79	3.87	4.33	4.14	4.22	3.12	3.6	1.95	2.3
16000	11.20	N/A	2.09	N/A	N/A	N/A	N/A	3.43	4.82	3.93	4.32	4.15	4.33	3.14	3.45	2	2.23
16400	11.48	N/A	1.99	N/A	N/A	N/A	N/A	3.46	5.03	3.95	4.41	4.16	4.32	3.25	3.47	2.01	2.33
16800	12.14	N/A	2.15	N/A	N/A	N/A	N/A	3.42	4.88	3.96	4.51	4.16	4.44	3.24	3.62	1.98	2.33
17200	12.97	N/A	2.17	N/A	N/A	N/A	N/A	3.5	5.03	4.06	4.51	4.27	4.49	3.36	3.71	2	2.36
17600	13.07	N/A	2.15	N/A	N/A	N/A	N/A	3.52	4.97	4.04	4.63	4.21	4.53	3.27	3.56	2.02	2.33
18000	13.70	N/A	2.16	N/A	N/A	N/A	N/A	3.49	5.07	4.25	4.68	4.33	4.54	3.31	3.84	2.05	2.47
18400	14.65	N/A	2.07	N/A	N/A	N/A	N/A	3.43	5.43	4.11	4.71	4.28	4.6	3.29	3.81	2.08	2.41
18800	14.69	N/A	2.25	N/A	N/A	N/A	N/A	3.46	5.37	4.31	4.82	4.32	4.56	3.32	3.63	2.12	2.51
19200	15.38	N/A	2.23	N/A	N/A	N/A	N/A	3.57	5.33	4.34	5.06	4.35	4.72	3.38	3.86	2.12	2.59
19600	15.65	N/A	2.26	N/A	N/A	N/A	N/A	3.71	5.44	4.27	5.12	4.39	4.72	3.37	3.78	2.16	2.46
20000	15.86	N/A	2.19	N/A	N/A	N/A	N/A	3.53	5.98	4.31	5.23	4.42	4.91	3.46	3.96	2.23	2.59

HWTD Results Mixture 13, 14, 15 and 16 (mm)

Number of Wheel Passes	Mixture 13				Mixture 14				Mixture 15			Mixture 16			
	Temperature														
	50	50	50	50	50	50	50	50	50	50	50	50	50	50	50
0	0.00	0.00	0.00	0.00	0.00	0.00	0.00	0.00	0.00	0.00	0.00	0.00	0.00	0.00	
100	0.73	1.75	0.63	0.79	0.44	0.66	0.54	0.51	0.54	0.61	0.47	0.85	0.79	0.92	
200	0.87	2.14	0.75	0.93	0.61	0.74	0.68	0.55	0.66	0.76	0.61	1.07	1.03	1.20	
300	0.94	2.39	0.85	1.07	0.70	0.80	0.75	0.66	0.76	0.88	0.68	1.21	1.19	1.33	
400	0.98	2.44	0.91	1.08	0.71	0.94	0.86	0.65	0.80	0.94	0.75	1.29	1.29	1.50	
500	1.05	2.51	1.00	1.21	0.71	0.90	0.92	0.72	0.87	0.98	0.81	1.38	1.37	1.71	
600	1.08	2.53	1.00	1.19	0.78	0.94	0.98	0.76	0.85	1.01	0.81	1.45	1.52	1.75	
700	1.06	2.70	1.07	1.27	0.73	0.97	1.00	0.77	0.91	1.11	0.85	1.46	1.56	1.81	
800	1.14	2.90	1.08	1.31	0.77	1.08	0.99	0.76	0.94	1.10	0.87	1.57	1.60	1.90	
900	1.12	2.74	1.10	1.35	0.75	1.11	1.02	0.84	1.00	1.08	0.91	1.57	1.71	2.02	

1000	1.20	2.73	1.18	1.34	0.84	1.14	1.03	0.89	1.01	1.13	0.92	1.70	1.74	2.16
1100	1.22	2.75	1.18	1.43	0.93	1.17	1.08	0.95	1.02	1.18	0.97	1.70	1.88	2.25
1200	1.18	2.75	1.26	1.47	0.83	1.19	1.07	0.94	1.04	1.21	1.02	1.74	1.84	2.32
1300	1.27	2.90	1.24	1.48	0.87	1.22	1.14	0.97	1.07	1.23	1.04	1.78	1.90	2.34
1400	1.24	2.95	1.26	1.55	0.90	1.17	1.20	0.99	1.06	1.20	1.06	1.86	1.94	2.31
1500	1.25	2.82	1.35	1.55	0.90	1.27	1.22	1.03	1.10	1.25	1.11	1.77	2.04	2.45
1600	1.31	3.16	1.36	1.59	0.97	1.22	1.19	1.05	1.12	1.31	1.14	1.91	2.01	2.40
1700	1.32	3.03	1.33	1.55	0.89	1.29	1.27	1.06	1.10	1.33	1.16	2.00	2.01	2.43
1800	1.29	2.94	1.37	1.58	0.95	1.29	1.20	1.04	1.09	1.36	1.16	1.96	2.07	2.50
1900	1.31	3.01	1.41	1.60	0.95	1.26	1.25	1.10	1.13	1.36	1.18	2.04	2.18	2.60
2000	1.32	3.06	1.43	1.60	1.04	1.28	1.32	1.08	1.20	1.35	1.17	2.00	2.15	2.70
2100	1.33	3.29	1.40	1.71	0.94	1.30	1.30	1.07	1.18	1.40	1.17	2.08	2.17	2.64
2200	1.33	3.16	1.44	1.70	1.00	1.30	1.25	1.07	1.14	1.40	1.22	2.11	2.24	2.65
2300	1.34	3.09	1.46	1.69	0.96	1.39	1.28	1.10	1.17	1.44	1.26	2.02	2.35	2.69
2400	1.36	3.23	1.48	1.69	1.09	1.43	1.28	1.13	1.20	1.48	1.28	2.13	2.27	2.73
2500	1.40	3.27	1.55	1.75	1.03	1.37	1.34	1.10	1.22	1.40	1.29	2.20	2.29	2.87
2600	1.43	3.29	1.57	1.75	1.02	1.42	1.36	1.11	1.25	1.47	1.31	2.19	2.31	2.81
2700	1.41	3.34	1.59	1.83	1.01	1.44	1.38	1.13	1.19	1.48	1.30	2.23	2.45	2.79
2800	1.44	3.34	1.56	1.75	1.10	1.46	1.37	1.20	1.24	1.50	1.29	2.20	2.36	2.83
2900	1.48	3.42	1.60	1.78	1.05	1.46	1.42	1.13	1.31	1.51	1.33	2.24	2.37	2.94
3000	1.43	3.36	1.57	1.80	1.06	1.48	1.42	1.18	1.31	1.52	1.32	2.16	2.45	3.02
3100	1.45	3.42	1.62	1.87	1.10	1.49	1.38	1.15	1.28	1.52	1.33	2.26	2.45	2.91
3200	1.50	3.39	1.60	1.90	1.04	1.50	1.45	1.18	1.24	1.48	1.37	2.31	2.49	2.95
3300	1.46	3.29	1.64	1.86	1.07	1.52	1.46	1.13	1.33	1.57	1.36	2.21	2.63	2.97
3400	1.46	3.36	1.65	1.87	1.17	1.55	1.42	1.20	1.30	1.54	1.40	2.22	2.51	2.96
3500	1.52	3.56	1.72	1.87	1.05	1.55	1.44	1.17	1.33	1.55	1.42	2.35	2.54	3.15
3600	1.48	3.48	1.74	1.99	1.10	1.56	1.46	1.17	1.35	1.57	1.41	2.38	2.53	3.11
3700	1.49	3.52	1.74	1.93	1.14	1.57	1.52	1.22	1.33	1.57	1.41	2.37	2.55	3.04
3800	1.57	3.49	1.70	1.92	1.12	1.56	1.53	1.24	1.35	1.61	1.42	2.43	2.57	3.08
3900	1.55	3.50	1.76	2.03	1.16	1.52	1.49	1.25	1.34	1.55	1.42	2.40	2.60	3.27
4000	1.50	3.41	1.76	2.03	1.19	1.61	1.47	1.23	1.38	1.61	1.43	2.40	2.74	3.28
4100	1.50	3.23	1.72	2.03	1.21	1.62	1.54	1.24	1.31	1.59	1.44	2.46	2.79	3.21
4200	1.51	3.59	1.75	2.00	1.10	1.57	1.55	1.21	1.37	1.62	1.46	2.45	2.80	3.23
4300	1.56	3.38	1.76	1.99	1.24	1.67	1.55	1.24	1.35	1.59	1.47	2.45	2.81	3.35
4400	1.56	3.65	1.82	2.11	1.12	1.64	1.54	1.26	1.38	1.64	1.49	2.37	2.70	3.30
4500	1.61	3.35	1.85	2.01	1.22	1.59	1.52	1.29	1.39	1.66	1.50	2.51	2.72	3.39
4600	1.54	3.61	1.83	2.05	1.20	1.67	1.60	1.28	1.38	1.60	1.51	2.54	2.75	3.38
4700	1.61	3.64	1.82	2.14	1.18	1.63	1.61	1.30	1.39	1.63	1.53	2.53	2.75	3.46
4800	1.56	3.42	1.86	2.08	1.16	1.72	1.60	1.32	1.41	1.66	1.52	2.56	2.96	3.42
4900	1.61	3.49	1.87	2.16	1.18	1.71	1.59	1.29	1.41	1.69	1.51	2.40	2.86	3.50
5000	1.58	3.43	1.88	2.08	1.20	1.64	1.61	1.26	1.45	1.70	1.55	2.53	2.84	3.67

5200	1.58	3.66	1.85	2.12	1.22	1.72	1.66	1.35	1.43	1.70	1.55	2.60	2.96	3.60
5400	1.64	3.50	1.91	2.15	1.17	1.74	1.66	1.33	1.45	1.72	1.58	2.61	2.96	3.63
5600	1.61	3.53	1.97	2.19	1.20	1.73	1.69	1.34	1.47	1.73	1.61	2.52	3.00	3.72
5800	1.68	3.55	1.95	2.19	1.16	1.76	1.67	1.38	1.39	1.74	1.61	2.63	3.04	3.91
6000	1.69	3.58	2.00	2.22	1.25	1.81	1.68	1.35	1.49	1.70	1.62	2.68	3.08	3.72
6200	1.65	3.82	1.99	2.39	1.32	1.77	1.73	1.37	1.47	1.73	1.61	2.57	3.33	3.80
6400	1.72	3.90	2.03	2.40	1.21	1.84	1.71	1.43	1.52	1.82	1.66	2.71	3.17	3.94
6600	1.76	3.61	2.02	2.40	1.24	1.88	1.68	1.39	1.49	1.78	1.69	2.77	3.42	4.14
6800	1.67	3.91	2.04	2.46	1.25	1.81	1.73	1.43	1.49	1.83	1.67	2.61	3.26	4.17
7000	1.70	3.64	2.06	2.38	1.29	1.87	1.75	1.42	1.53	1.83	1.68	2.80	3.31	4.07
7200	1.77	3.71	2.11	2.38	1.31	1.85	1.69	1.42	1.52	1.85	1.71	2.81	3.34	4.34
7400	1.74	3.93	2.14	2.40	1.30	1.87	1.80	1.45	1.52	1.85	1.74	2.85	3.37	4.25
7600	1.76	3.64	2.10	2.42	1.39	1.87	1.75	1.53	1.52	1.89	1.75	2.84	3.40	4.41
7800	1.84	3.91	2.15	2.61	1.32	1.88	1.80	1.48	1.57	1.87	1.76	2.90	3.43	4.50
8000	1.81	3.73	2.14	2.57	1.35	1.96	1.75	1.51	1.57	1.85	1.77	2.91	3.47	4.28
8200	1.86	3.80	2.20	2.47	1.32	1.96	1.80	1.53	1.58	1.90	1.78	2.77	3.51	4.45
8400	1.76	3.80	2.18	2.51	1.37	1.96	1.82	1.51	1.62	1.91	1.77	2.79	3.76	4.42
8600	1.80	3.93	2.25	2.68	1.32	2.01	1.78	1.56	1.60	1.95	1.77	2.80	3.85	4.43
8800	1.85	3.75	2.24	2.57	1.39	1.97	1.80	1.56	1.59	1.94	1.82	2.99	3.70	4.49
9000	1.81	3.98	2.22	2.82	1.35	1.97	1.85	1.63	1.55	1.96	1.81	3.00	3.65	4.46
9200	1.83	3.77	2.30	2.69	1.36	2.02	1.90	1.63	1.61	1.96	1.84	3.03	3.94	4.69
9400	1.92	4.11	2.29	2.73	1.38	2.12	1.84	1.59	1.62	1.96	1.82	3.02	3.76	4.92
9600	1.93	3.87	2.27	2.92	1.34	2.15	1.89	1.66	1.64	2.01	1.82	3.04	3.79	4.82
9800	1.85	3.85	2.29	2.98	1.36	2.05	1.91	1.65	1.59	2.04	1.86	2.89	3.77	4.79
10000	1.94	4.08	2.31	2.79	1.39	2.09	1.94	1.64	1.58	2.02	1.87	3.07	3.87	5.10
10400	1.85	4.13	2.32	3.07	1.45	2.11	1.98	1.70	1.65	1.98	1.86	2.96	3.94	5.29
10800	1.93	4.23	2.35	2.90	1.44	2.15	1.93	1.69	1.68	2.04	1.91	3.00	4.00	5.39
11200	1.89	4.03	2.39	3.13	1.44	2.17	2.01	1.73	1.63	2.07	1.91	3.17	4.10	5.52
11600	1.93	3.97	2.42	2.97	1.46	2.21	2.04	1.77	1.67	2.07	1.91	3.20	4.08	5.41
12000	1.98	3.90	2.52	3.10	1.48	2.30	2.11	1.83	1.73	2.09	1.92	3.26	4.30	5.48
12400	2.04	4.03	2.47	3.15	1.59	2.33	2.10	1.79	1.71	2.15	1.97	3.28	4.20	5.57
12800	2.04	4.43	2.57	3.19	1.58	2.24	2.09	1.83	1.67	2.15	1.97	3.33	4.35	5.72
13200	2.02	4.42	2.56	3.43	1.61	2.27	2.16	1.89	1.77	2.14	1.99	3.35	4.69	6.12
13600	1.99	4.34	2.55	3.39	1.70	2.34	2.23	1.88	1.75	2.09	1.98	3.39	4.63	5.96
14000	2.01	4.38	2.60	3.53	1.71	2.38	2.24	1.92	1.72	2.20	2.01	3.25	4.57	6.36
14400	2.12	4.44	2.60	3.49	1.70	2.34	2.20	1.93	1.81	2.14	2.05	3.28	4.68	6.47
14800	2.13	4.16	2.67	3.60	1.74	2.51	2.21	1.97	1.81	2.23	2.03	3.30	4.79	6.30
15200	2.05	4.29	2.64	3.46	1.75	2.39	2.32	2.00	1.81	2.24	2.06	3.53	4.98	6.66
15600	2.05	4.59	2.67	3.70	1.78	2.48	2.34	2.02	1.83	2.15	2.10	3.52	4.86	6.75
16000	2.07	4.37	2.73	3.44	1.78	2.42	2.32	2.06	1.83	2.27	2.08	3.56	4.99	6.54
16400	2.12	4.41	2.72	3.82	1.78	2.46	2.32	2.09	1.82	2.30	2.12	3.42	5.33	6.67

16800	2.09	4.66	2.74	3.53	1.82	2.48	2.36	2.12	1.88	2.31	2.11	3.46	4.98	6.76
17200	2.10	4.67	2.82	3.80	1.79	2.71	2.37	2.09	1.88	2.26	2.13	3.68	5.09	6.96
17600	2.11	4.47	2.86	3.98	1.80	2.66	2.41	2.14	1.86	2.24	2.17	3.75	5.22	7.29
18000	2.22	4.72	2.84	3.89	1.85	2.71	2.49	2.18	1.85	2.33	2.17	3.76	5.42	7.06
18400	2.17	4.75	2.91	4.04	1.83	2.72	2.54	2.21	1.87	2.35	2.19	3.82	5.29	7.53
18800	2.14	4.52	2.84	3.91	1.80	2.75	2.61	2.23	1.87	2.39	2.18	3.78	5.61	7.40
19200	2.12	4.83	2.94	4.15	1.85	2.78	2.62	2.30	1.83	2.40	2.18	3.88	5.53	7.74
19600	2.22	4.87	2.85	4.24	1.85	2.83	2.71	2.32	1.90	2.39	2.19	3.68	5.87	7.45
20000	2.19	4.62	2.88	4.15	1.89	2.83	2.74	2.36	1.93	2.43	2.24	3.71	6.45	7.61

HWTD Results Mixture 17, 18, 19 and 20 (mm)

Number of Wheel Passes	Mixture 17			Mixture 18			Mixture 19			Mixture 20		
	Temperature											
	50	50	50	50	50	50	50	50	50	50	50	50
0	0.00	0.00	0.00	0.00	0.00	0.00	0.00	0.00	0.00	0.00	0.00	0.00
100	0.53	0.72	0.52	0.53	0.48	0.45	0.68	0.55	0.60	0.69	0.40	0.49
200	0.67	0.94	0.58	0.62	0.61	0.61	0.89	0.71	0.79	0.79	0.65	0.63
300	0.75	1.01	0.68	0.76	0.72	0.66	1.03	0.77	0.87	0.85	0.65	0.70
400	0.78	1.13	0.79	0.83	0.72	0.75	1.12	0.89	0.93	0.86	0.66	0.79
500	0.87	1.19	0.77	0.84	0.80	0.80	1.20	0.93	1.03	0.92	0.71	0.84
600	0.92	1.25	0.83	0.87	0.83	0.82	1.28	1.03	1.09	0.99	0.76	0.87
700	0.95	1.28	0.83	0.94	0.85	0.93	1.26	1.07	1.15	1.02	0.77	0.90
800	0.95	1.35	0.88	1.00	0.89	0.97	1.32	1.13	1.18	0.98	0.92	0.95
900	1.03	1.39	0.92	0.98	0.92	0.97	1.39	1.20	1.22	1.00	0.92	0.98
1000	1.05	1.46	0.94	1.09	0.97	0.98	1.46	1.24	1.29	1.04	0.93	1.01
1100	1.08	1.45	0.98	1.14	0.99	1.10	1.63	1.30	1.31	1.10	0.85	1.05
1200	1.11	1.51	0.98	1.16	0.99	1.09	1.68	1.32	1.39	1.09	0.99	1.03
1300	1.12	1.54	1.02	1.12	1.01	1.13	1.70	1.38	1.39	1.08	0.99	1.05
1400	1.15	1.60	1.05	1.12	1.05	1.12	1.77	1.44	1.44	1.07	0.99	1.10
1500	1.17	1.62	1.04	1.16	1.08	1.22	1.79	1.47	1.46	1.07	0.97	1.14
1600	1.17	1.64	1.07	1.20	1.06	1.20	1.84	1.50	1.50	1.11	1.06	1.14
1700	1.17	1.61	1.15	1.26	1.07	1.16	1.85	1.54	1.51	1.18	0.98	1.15
1800	1.23	1.69	1.11	1.28	1.09	1.22	1.88	1.60	1.56	1.13	1.03	1.14
1900	1.22	1.70	1.12	1.30	1.13	1.18	1.92	1.59	1.62	1.20	1.09	1.19
2000	1.27	1.69	1.16	1.26	1.11	1.26	1.86	1.61	1.63	1.11	1.05	1.19
2100	1.27	1.71	1.19	1.26	1.13	1.28	1.91	1.67	1.63	1.14	0.99	1.20
2200	1.27	1.76	1.20	1.30	1.17	1.26	1.93	1.76	1.67	1.16	1.09	1.23
2300	1.29	1.80	1.20	1.29	1.16	1.24	2.06	1.77	1.69	1.15	1.15	1.18
2400	1.31	1.81	1.22	1.39	1.16	1.32	2.08	1.76	1.73	1.15	1.06	1.20

2500	1.34	1.80	1.28	1.31	1.21	1.30	2.12	1.82	1.77	1.19	1.07	1.24
2600	1.35	1.86	1.25	1.35	1.24	1.38	2.16	1.87	1.74	1.24	1.03	1.26
2700	1.37	1.83	1.31	1.35	1.25	1.42	2.17	1.89	1.77	1.24	1.17	1.22
2800	1.37	1.89	1.29	1.38	1.25	1.36	2.21	1.90	1.78	1.20	1.11	1.23
2900	1.36	1.87	1.31	1.40	1.26	1.37	2.22	1.88	1.81	1.27	1.09	1.23
3000	1.38	1.93	1.35	1.39	1.29	1.41	2.22	1.97	1.86	1.19	1.04	1.27
3100	1.39	1.91	1.29	1.39	1.28	1.41	2.25	1.93	1.86	1.27	1.13	1.27
3200	1.41	1.93	1.30	1.48	1.28	1.42	2.30	1.96	1.86	1.20	1.16	1.26
3300	1.41	1.95	1.39	1.43	1.31	1.49	2.32	1.99	1.87	1.27	1.06	1.28
3400	1.43	1.93	1.32	1.42	1.32	1.44	2.32	2.02	1.94	1.29	1.16	1.32
3500	1.43	1.95	1.40	1.50	1.30	1.43	2.37	2.05	1.92	1.23	1.09	1.35
3600	1.42	1.99	1.38	1.44	1.35	1.52	2.42	2.07	1.93	1.22	1.10	1.33
3700	1.44	1.94	1.37	1.52	1.36	1.49	2.42	2.08	1.96	1.25	1.18	1.33
3800	1.48	1.96	1.37	1.50	1.37	1.56	2.36	2.12	1.96	1.30	1.20	1.39
3900	1.46	1.98	1.45	1.47	1.35	1.52	2.46	2.16	1.98	1.31	1.21	1.34
4000	1.48	1.98	1.40	1.52	1.40	1.50	2.49	2.15	2.02	1.32	1.13	1.36
4100	1.50	2.03	1.40	1.57	1.37	1.54	2.49	2.13	2.02	1.32	1.18	1.34
4200	1.50	2.07	1.43	1.54	1.41	1.57	2.54	2.21	2.06	1.33	1.20	1.41
4300	1.48	2.02	1.41	1.55	1.39	1.59	2.56	2.23	2.05	1.29	1.25	1.37
4400	1.50	2.09	1.45	1.57	1.43	1.59	2.57	2.18	2.06	1.32	1.15	1.39
4500	1.51	2.01	1.47	1.57	1.44	1.59	2.59	2.24	2.10	1.35	1.20	1.37
4600	1.50	2.12	1.45	1.59	1.44	1.56	2.65	2.27	2.10	1.26	1.21	1.45
4700	1.53	2.06	1.45	1.59	1.44	1.60	2.66	2.31	2.15	1.28	1.15	1.43
4800	1.54	2.11	1.49	1.59	1.45	1.67	2.68	2.28	2.15	1.29	1.20	1.43
4900	1.55	2.09	1.54	1.63	1.50	1.70	2.70	2.31	2.16	1.29	1.17	1.41
5000	1.55	2.17	1.50	1.61	1.52	1.66	2.71	2.34	2.16	1.31	1.29	1.45
5200	1.55	2.12	1.50	1.60	1.52	1.69	2.74	2.34	2.20	1.31	1.23	1.47
5400	1.57	2.17	1.57	1.69	1.53	1.68	2.75	2.33	2.26	1.38	1.31	1.47
5600	1.57	2.18	1.54	1.63	1.51	1.71	2.79	2.42	2.27	1.43	1.24	1.49
5800	1.62	2.17	1.58	1.65	1.51	1.77	2.85	2.41	2.25	1.41	1.24	1.53
6000	1.62	2.26	1.61	1.69	1.57	1.70	2.89	2.44	2.31	1.44	1.23	1.56
6200	1.66	2.21	1.60	1.74	1.54	1.80	2.86	2.44	2.38	1.45	1.26	1.51
6400	1.65	2.27	1.60	1.75	1.56	1.83	2.90	2.45	2.33	1.39	1.25	1.53
6600	1.66	2.28	1.60	1.77	1.61	1.82	2.93	2.51	2.36	1.44	1.29	1.51
6800	1.70	2.27	1.68	1.77	1.59	1.81	2.96	2.51	2.40	1.42	1.33	1.56
7000	1.68	2.29	1.65	1.75	1.64	1.76	3.02	2.59	2.44	1.40	1.27	1.60
7200	1.68	2.32	1.71	1.75	1.61	1.86	3.02	2.56	2.49	1.48	1.32	1.60
7400	1.72	2.39	1.68	1.79	1.70	1.85	2.98	2.60	2.50	1.50	1.38	1.61
7600	1.73	2.29	1.72	1.80	1.65	1.83	3.15	2.67	2.49	1.44	1.32	1.62
7800	1.76	2.37	1.69	1.78	1.72	1.86	3.16	2.61	2.52	1.43	1.32	1.63
8000	1.76	2.39	1.71	1.86	1.72	1.88	3.13	2.63	2.54	1.44	1.39	1.69

8200	1.78	2.44	1.76	1.82	1.68	1.86	3.22	2.69	2.55	1.45	1.32	1.63
8400	1.75	2.39	1.73	1.89	1.77	1.97	3.27	2.73	2.61	1.48	1.37	1.64
8600	1.81	2.39	1.73	1.84	1.71	1.91	3.25	2.72	2.58	1.48	1.37	1.70
8800	1.79	2.46	1.76	1.87	1.76	1.93	3.27	2.71	2.58	1.44	1.45	1.72
9000	1.80	2.51	1.76	1.93	1.79	1.91	3.32	2.75	2.57	1.51	1.44	1.67
9200	1.83	2.51	1.78	1.86	1.79	1.96	3.34	2.75	2.64	1.46	1.43	1.73
9400	1.80	2.53	1.80	1.89	1.82	1.99	3.40	2.85	2.63	1.50	1.44	1.68
9600	1.81	2.48	1.84	1.96	1.84	2.00	3.41	2.86	2.66	1.47	1.50	1.75
9800	1.81	2.54	1.87	1.90	1.79	2.07	3.36	2.80	2.68	1.55	1.38	1.73
10000	1.84	2.52	1.88	1.93	1.80	2.01	3.46	2.80	2.70	1.58	1.43	1.70
10400	1.86	2.56	1.85	1.92	1.83	2.09	3.50	2.84	2.77	1.53	1.48	1.79
10800	1.89	2.56	1.89	2.01	1.92	2.05	3.40	2.95	2.79	1.52	1.51	1.77
11200	1.90	2.69	1.91	1.99	1.92	2.05	3.52	2.93	2.83	1.57	1.48	1.83
11600	1.95	2.75	1.93	2.06	1.90	2.07	3.52	2.93	2.87	1.55	1.49	1.82
12000	1.95	2.76	1.96	2.02	2.01	2.15	3.58	2.97	2.87	1.54	1.50	1.85
12400	1.99	2.77	2.01	2.07	2.02	2.13	3.72	3.04	2.91	1.63	1.53	1.85
12800	2.01	2.77	2.05	2.09	1.96	2.19	3.75	3.05	2.91	1.57	1.48	1.93
13200	2.00	2.78	2.05	2.12	2.04	2.24	3.80	3.08	2.89	1.58	1.54	1.89
13600	2.02	2.85	2.05	2.14	2.06	2.25	3.73	3.10	3.01	1.59	1.55	1.87
14000	2.05	2.79	2.08	2.13	2.08	2.22	3.77	3.22	3.01	1.63	1.54	1.98
14400	2.03	2.78	2.12	2.21	2.11	2.29	3.87	3.17	3.06	1.62	1.52	1.95
14800	2.13	2.77	2.18	2.19	2.11	2.25	3.74	3.19	3.06	1.69	1.60	1.98
15200	2.12	2.88	2.22	2.22	2.13	2.30	3.94	3.27	3.08	1.62	1.53	2.04
15600	2.17	2.90	2.29	2.27	2.15	2.27	3.98	3.20	3.12	1.63	1.62	1.95
16000	2.21	2.97	2.25	2.28	2.11	2.39	3.93	3.24	3.16	1.69	1.63	2.04
16400	2.20	2.92	2.29	2.25	2.18	2.36	4.07	3.28	3.10	1.70	1.60	2.01
16800	2.27	2.93	2.34	2.31	2.23	2.32	4.04	3.37	3.16	1.65	1.65	2.07
17200	2.29	2.93	2.41	2.28	2.14	2.34	4.07	3.29	3.23	1.66	1.66	2.01
17600	2.25	2.92	2.46	2.34	2.24	2.41	4.06	3.32	3.16	1.66	1.69	2.07
18000	2.34	2.97	2.50	2.31	2.31	2.43	4.20	3.41	3.23	1.71	1.63	2.00
18400	2.31	2.95	2.48	2.33	2.32	2.49	4.14	3.35	3.21	1.76	1.66	2.14
18800	2.35	2.95	2.55	2.36	2.24	2.45	4.14	3.41	3.29	1.71	1.70	2.13
19200	2.45	3.02	2.53	2.35	2.25	2.46	4.22	3.40	3.34	1.71	1.81	2.11
19600	2.47	3.03	2.60	2.39	2.36	2.47	4.34	3.53	3.39	1.76	1.81	2.13
20000	2.51	3.07	2.61	2.35	2.37	2.57	4.41	3.58	3.41	1.73	1.75	2.25